

HQ *Sweet Sixteen*®

USER MANUAL

QM30277 • Version 3.3



Handi Quilter
BY QUILTERS FOR QUILTERS



Handi Quilter
BY QUILTERS FOR QUILTERS

Congratulations on your purchase of the HQ Sweet Sixteen from Handi Quilter!

You haven't just purchased a quilting machine, you've joined the Handi Quilter family and we welcome you.

Handi Quilter is committed to innovation, reliability, customer service and education. Our machines are "Designed by a Quilter, for Quilters®" and we are committed to your quilting success.

With that in mind, we invite you to bookmark our website: www.HandiQuilter.com and invite you to visit to learn more about the art of quilting. We've posted tips, tricks and tutorials on subjects as diverse as "Oiling Your Machine" to "Loading a Quilt" to "Making Perfect Feathers". We've got videos to watch, pdf files to print out for reference and forums for asking questions.

Remember, if you ever have questions, your local Retailer can help you. If the Retailer is not available, contact Handi Quilter directly at techsupport@HandiQuilter.com or by calling us at 1-877-697-8458, Monday-Friday, 8-5 MST.

Handi Quilter® and HQ Sweet Sixteen® are either trademarks or registered trademarks of Handi Quilter, Inc.
Digital tensioner U.S. Patent No. 8,997,669.

Printed in the United States of America.

Table of Contents

4	Safety Section
5	Quick Facts
9	Components (Front Side View)
10	Components (Back Side View)
11	Components (Rear and Front Views)
12	Setting Up the Table Placing Machine in Table Installing Power Cord Installing Foot Pedal
13	Installing Thread Mast Installing Color Touch-Screen
14	Inserting Needle Needle/Thread Selection Guide
15	Changing the Hopping Foot
16	Threading the Machine
18	Bobbin Case and Bobbin Thread Tension Adjustments
19	Easy-Set Tension™ Adjustment
20	Maintenance
21	Using the Touch-Screen Display
30	Getting Started Quilting
31	Correcting Common Issues
34	Optional Accessories
35	Warranty
37	Warranty Registration Form
39	Training Checklist



NOTE: A Handi Quilter “Getting Started” set of DVDs is included with your HQ Sweet Sixteen machine. Review the DVDs and these instructions to better understand how to set up and use the HQ Sweet Sixteen.

Safety Section

This device complies with Part 15 of the FCC Rules. Operation is subject to the following two conditions: (1) This device may not cause harmful interference, and (2) this device must accept any interference received, including interference that may cause undesired operation.

Please note: Do not operate your HQ Sweet Sixteen quilting machine until you have completely read the information contained in this manual. Please keep all packaging and order information for warranty purposes.

IMPORTANT SAFETY INSTRUCTIONS

Read all instructions before using this machine.

When using this machine, basic safety precautions should always be followed, including the following:

DANGER — To reduce the risk of electric shock:

A quilting machine should never be left unattended when plugged in. Always unplug the machine from the electrical outlet immediately after using and before cleaning.

WARNING — To reduce the risk of burns, fire, electric shock, or injury to persons:

- The HQ Sweet Sixteen is heavy. Never attempt to lift it alone. Always use two people when lifting. Always lift from the throat of the machine, not from the handlebars.
- Always unplug the HQ Sweet Sixteen from the electrical outlet when performing any maintenance, changing the needle, removing thread locks, or when left unattended.
- Do not unplug by pulling on cord. To unplug, grasp the plug, not the cord.
- Keep fingers away from all moving parts. Use caution around the needle or sharp external components.
- Change the needle often. Do not use bent or dull needles. "Every quilt deserves a new needle".
- Switch the machine to the symbol off, or

0, position to turn it off when making any adjustments in the needle area, such as threading needle, changing needle, threading bobbin, changing hopping foot, and so forth.

- Never drop or insert foreign objects into any opening.
- The HQ Sweet Sixteen should only be used indoors away from moisture.
- The HQ Sweet Sixteen should not be stored or used in extreme temperatures.
- Use the HQ Sweet Sixteen only for its intended use as described in this manual.
- To disconnect from the wall outlet, push the switch to the off position, then remove the plug from outlet pulling from the plug, not the cord. Never operate the HQ Sweet Sixteen if the cord is damaged or not working correctly. If a mechanical or electrical problem is encountered, return the HQ Sweet Sixteen to the nearest authorized service center or the manufacturer for examination, repair, electrical, or mechanical adjustment.
- It is not recommended that the HQ Sweet Sixteen quilting machine be used with any machine quilting frame other than those recommended by Handi Quilter.
- Use this quilting machine only for its intended use as described in this manual. Use only attachments recommended by the manufacturer as contained in this manual.
- Never operate the machine with any air openings blocked. Keep ventilation openings of the machine free from the accumulation of lint, dust, and loose cloth.
- Do not operate where aerosol (spray) products are being used or where oxygen is being administered.
- Do not pull or push the fabric excessively while stitching. It may deflect the needle enough to cause it to break.
- Use only needles designed for free motion quilting and recommended by Handi Quilter for this machine. Other types of needles may be break during normal quilting.
- Children shall not play with the machine. Close attention is necessary when this machine is used by or near children.
- This sewing machine may be used by children age 8 years and above and persons with reduced

physical, sensory, or mental capabilities or lack of experience and knowledge if they have been given supervision or instruction concerning use of the machine in a safe way and understand the hazards involved.

- Cleaning and user maintenance shall not be made by children without supervision.

Save these instructions.

This machine is intended for household use.

Disclaimer

Handi Quilter and its Representatives are in no way legally responsible or liable for damage to the HQ Sweet Sixteen when used improperly or not in accordance with the guidelines stated in this manual or when used on machine quilting frames not recommended by Handi Quilter.

To use the machine safely

Carefully watch the needle when sewing. Do not touch the hand wheel, take up lever, needle, or other moving parts.

Turn the machine off and unplug the cord in the following cases: when you have stopped using the machine when you replace or remove the needle or any other part when you check or clean the machine when you leave the machine unattended

Connect the machine directly to the wall outlet or to a surge protector that connects directly to the wall outlet. Do not use extension cords.

To increase the life of your machine

Do not store this machine in areas exposed to direct sunlight or high humidity. Never use or store the machine near a heater, an iron, a halogen lamp or other hot things.

Use only neutral soaps or detergents to clean the machine. Benzene, solvents and scouring powders can damage the case and the machine and therefore should never be used.

Do not drop or bump the machine.

HandiQuilter.com

Always consult the manual to replace or fix the hopping foot, needle or any other part of the machine. If necessary contact an authorized Handi Quilter representative or Handi Quilter technical support.

Quick Facts

The HQ Sweet Sixteen utilizes high-tech electronics and an innovative touch-pad user interface to offer greater functionality and ease of operation to home quilters than ever before conceived in the quilting industry. The HQ Sweet Sixteen quilting machine is a high quality machine that incorporates very robust design features and is very easy to service.

Throat Dimensions: 8.25" X 16"
(245 mm X 610 mm)

Quilting Speed: Maximum: 1500 SPM

Needle System: 134 (135 X 7)

Needle Sizes: 12/80 - 20/125

Hook System: Rotary, Horizontal axis,
M-class bobbin

Bobbin Type: Aluminum, Class M

Bobbin Case: Type MF

Motor Type: Brushless DC

Needle Positioning: Up and down, tieoff stitch

Electrical Power:

US/Canada*: 105 – 120 VAC, 47-63Hz,
300W peak

Rest of world: 100 – 250 VAC, 47-63Hz,
300W peak

* Complies with
international certifications

LED Power Consumption: 2.25W

Hopping Foot Stroke/Lift: 5 mm

Needle Bar Stroke: 35.3 mm

Take-Up Stroke: 73 mm

**Lubrication, main
components:** Kluber Lube, permanent

Lubrication of hook: Velocite 10, Texaco 22

Disclaimer

Handi Quilter and its Representatives are in no way legally responsible or liable for damage to the HQ Sweet Sixteen when used improperly or not in accordance with the guidelines stated in this manual or when used on machine-quilting tables not recommended by Handi Quilter.

Consignes de sécurité

Cet appareil est conforme à la partie 15 de la réglementation de la FCC. Son fonctionnement est soumis aux deux conditions suivantes : (1) cet appareil ne doit pas causer d'interférences nuisibles, et (2) cet appareil doit accepter toute interférence reçue, y compris les interférences pouvant provoquer un fonctionnement indésirable.

Veuillez noter : n'utilisez pas votre machine à quilter HQ Sweet Sixteen avant d'avoir lu entièrement les informations contenues dans ce manuel. Veuillez conserver tous les emballages et les informations de commande à des fins de garantie.

CONSIGNES DE SÉCURITÉ IMPORTANTES

Lisez toutes les consignes avant d'utiliser la machine.

Lorsque vous utilisez cette machine, vous devez toujours prendre des précautions de sécurité de base, notamment ce qui suit :

DANGER — Pour réduire le risque de choc électrique :

Une machine à quilter ne doit jamais être laissée sans surveillance lorsqu'elle est branchée.

Débranchez toujours la machine de la prise électrique immédiatement après usage et avant de la nettoyer.

AVERTISSEMENT — Pour réduire le risque de brûlures, d'incendie, de choc électrique ou de blessures :

- La HQ Sweet Sixteen est très lourde. Ne jamais tenter de la soulever seul. Utilisez toujours deux personnes pour la soulever. Soulevez toujours la machine à partir de la gorge, non pas à partir des poignées.
- Débranchez toujours la HQ Sweet Sixteen de la prise électrique lors des travaux d'entretien, du changement d'aiguille, de la suppression des blocages de fil, ou lorsqu'elle est laissée sans surveillance.
- Ne pas débrancher en tirant sur le cordon. Pour débrancher, saisir la fiche, non le cordon.
- N'approchez pas les doigts des parties mobiles. Faites preuve de prudence lorsque vous vous approchez de l'aiguille ou de composants externes tranchants.
- Changez souvent d'aiguille. N'utilisez pas d'aiguilles tordues ou émoussées. « Chaque quilt mérite une nouvelle aiguille ».

- Mettez la machine sur la position 0 ou de symbole d'arrêt pour l'éteindre lorsque vous effectuez des réglages dans la zone de l'aiguille : enfilage de l'aiguille, changement d'aiguille, bobinage de la canette, changement de pied, etc.
- Ne faites jamais tomber et n'insérez jamais d'objets étrangers dans une ouverture.
- La HQ Sweet Sixteen doit être utilisée uniquement à l'intérieur dans un endroit non humide.
- La HQ Sweet Sixteen ne doit pas être rangée ou utilisée à des températures extrêmes.
- Utilisez la HQ Sweet Sixteen uniquement pour son usage prévu indiqué dans ce manuel.
- Pour débrancher la machine de la prise murale, mettez l'interrupteur sur arrêt, puis retirez la fiche de la prise en tirant à partir de la fiche et non du cordon. N'utilisez jamais la HQ Sweet Sixteen si le cordon est endommagé ou ne fonctionne pas correctement. En cas de problème mécanique ou électrique, renvoyez la HQ Sweet Sixteen au centre de service agréé le plus proche ou au fabricant pour inspection, réparation, ou réglage électrique ou mécanique.
- Il est déconseillé d'utiliser la machine à quilting HQ Sweet Sixteen avec un cadre de machine à quilter autre que ceux recommandés par Handi Quilter.
- Utilisez cette machine à quilter uniquement pour l'usage prévu décrit dans ce manuel. Utilisez uniquement les accessoires recommandés par le fabricant décrits dans ce manuel.
- Ne jamais utiliser la machine si des ouvertures d'air sont bloquées. Gardez les ouvertures de ventilation de la machine exemptes d'accumulation de peluches, poussières et morceaux de tissu.
- Ne pas utiliser là où des aérosols (vaporisateurs) sont utilisés ou de l'oxygène est administré.
- Ne pas tirer ni pousser trop fort la machine sur le tissu lors de l'exécution des points. Cela pourrait provoquer une déviation de l'aiguille et entraîner la fracture.
- N'utilisez que les aiguilles conçues pour le quilting en piqué libre et recommandées par Handi Quilter pour cette machine. D'autres types d'aiguilles risqueraient de se fracturer au cours d'un quilting normal.
- Ne pas laisser les enfants jouer avec la machine. Une attention particulière est nécessaire lorsque cette machine est utilisée par ou à proximité d'enfants.
- Cette machine peut être utilisée par des enfants de 8 ans et plus, ainsi que par des personnes atteintes d'un déficit physique, sensoriel ou mental, peu expérimentées ou ayant peu de connaissances, à condition que ces personnes reçoivent les instructions de sécurité et la supervision nécessaires à l'utilisation de la machine et qu'elles comprennent les risques encourus.

- Les travaux de maintenance et de nettoyage ne peuvent pas être effectués par des enfants sans supervision.

Conservez ces consignes.

Cette machine est destinée à un usage domestique.

Avertissement

Handi Quilter et ses représentants ne sont en aucun cas juridiquement responsables des dommages causés à la HQ Sweet Sixteen lorsque celle-ci est utilisée de manière inadéquate ou non conforme aux consignes énoncées dans ce manuel ou lorsqu'elle est utilisée sur des cadres de machine à quilter non recommandés par Handi Quilter.

Pour utiliser la machine en toute sécurité

Surveillez attentivement l'aiguille lors de la couture. Ne touchez pas le volant, le levier de releveur, l'aiguille ou d'autres pièces mobiles.

Mettez la machine hors tension et débranchez le cordon dans les cas suivants : lorsque vous cessez d'utiliser la machine, lorsque vous remplacez ou retirez l'aiguille ou toute autre pièce, lorsque vous vérifiez ou nettoyez la machine lorsque vous laissez la machine sans surveillance

Branchez la machine directement à la prise murale ou à un parasurtenseur qui se branche directement à la prise murale. Ne pas utiliser de rallonges.

Pour augmenter la durée de vie de votre machine

Ne pas ranger cette machine dans des endroits exposés à la lumière directe du soleil ou à une forte humidité. Ne jamais utiliser ni ranger la machine à proximité d'un radiateur, d'un fer à repasser, d'une lampe halogène ou d'autres objets brûlants.

Utilisez uniquement des savons ou détergents neutres pour nettoyer la machine. Le benzène, les solvants et les poudres à récurer peuvent endommager le boîtier et la machine et ne doivent donc jamais être utilisés.

Ne pas faire tomber ou cogner la machine.

Consultez toujours le manuel pour remplacer ou réparer le pied, l'aiguille ou toute autre pièce de la machine. Si nécessaire, contactez un représentant Handi Quilter agréé ou l'assistance technique Handi Quilter.

HandiQuilter.com

Spécifications

La HQ Sweet Sixteen utilise de l'électronique de pointe et une interface utilisateur innovante à base de pavé tactile afin d'offrir aux quilteuses à domicile un niveau de fonctionnalités et une facilité d'utilisation inégalés dans l'industrie du quilting. La machine à quilter HQ Sweet Sixteen est une machine de grande qualité qui intègre des fonctions de conception très robustes et qui est très facile à entretenir.

Dimensions de la gorge : 245 mm X 610 mm
(8,25" X 16")

Vitesse de quilting : Maximum : 1500 PPM

Système d'aiguille : 134 (135 X 7)

Tailles d'aiguille : 12/80 - 20/125

Système de crochet : Rotatif, axe horizontal, canette de classe M

Type de canette : Aluminium, classe M

Boîtier de canette : Type MF

Type de moteur : Sans balais à c.c.

Positionnement de l'aiguille : En haut et en bas, point d'arrêt

Alimentation électrique :

États-Unis/Canada* : 105 – 120 V c.a., 47-63 Hz, crête de 300 W

Reste du monde: 100 – 250 V c.a., 47-63 Hz, crête de 300 W

* Conforme aux certifications internationales

Consommation électrique de l'éclairage LED : 2,25 W

Course / Levée du pied : 5 mm

Course de la barre d'aiguille : 35,3 mm

Course du releveur : 73 mm

Lubrification, principaux composants : Lubrifiant Kluber, permanent

Lubrification du crochet : Velocite 10, Texaco 22

Avertissement

Handi Quilter et ses représentants ne sont en aucun cas juridiquement responsables des dommages causés à la HQ Sweet Sixteen lorsque celle-ci est utilisée de manière inadéquate ou non conforme aux consignes énoncées dans ce manuel ou lorsqu'elle est utilisée sur des tables de machine à quilter non recommandées par Handi Quilter.

To repair or adjust the machine

If the machine breaks down or needs adjustment, first check the troubleshooting chart in the appendix to inspect and adjust the machine yourself.

For more product information and updates, visit our website at www.HandiQuilter.com.

The contents of this manual and product specifications are subject to change without prior notice.

Check for updated manuals at www.handiquilter.com/manuals/.

HQ Sweet Sixteen Components

Front Side View

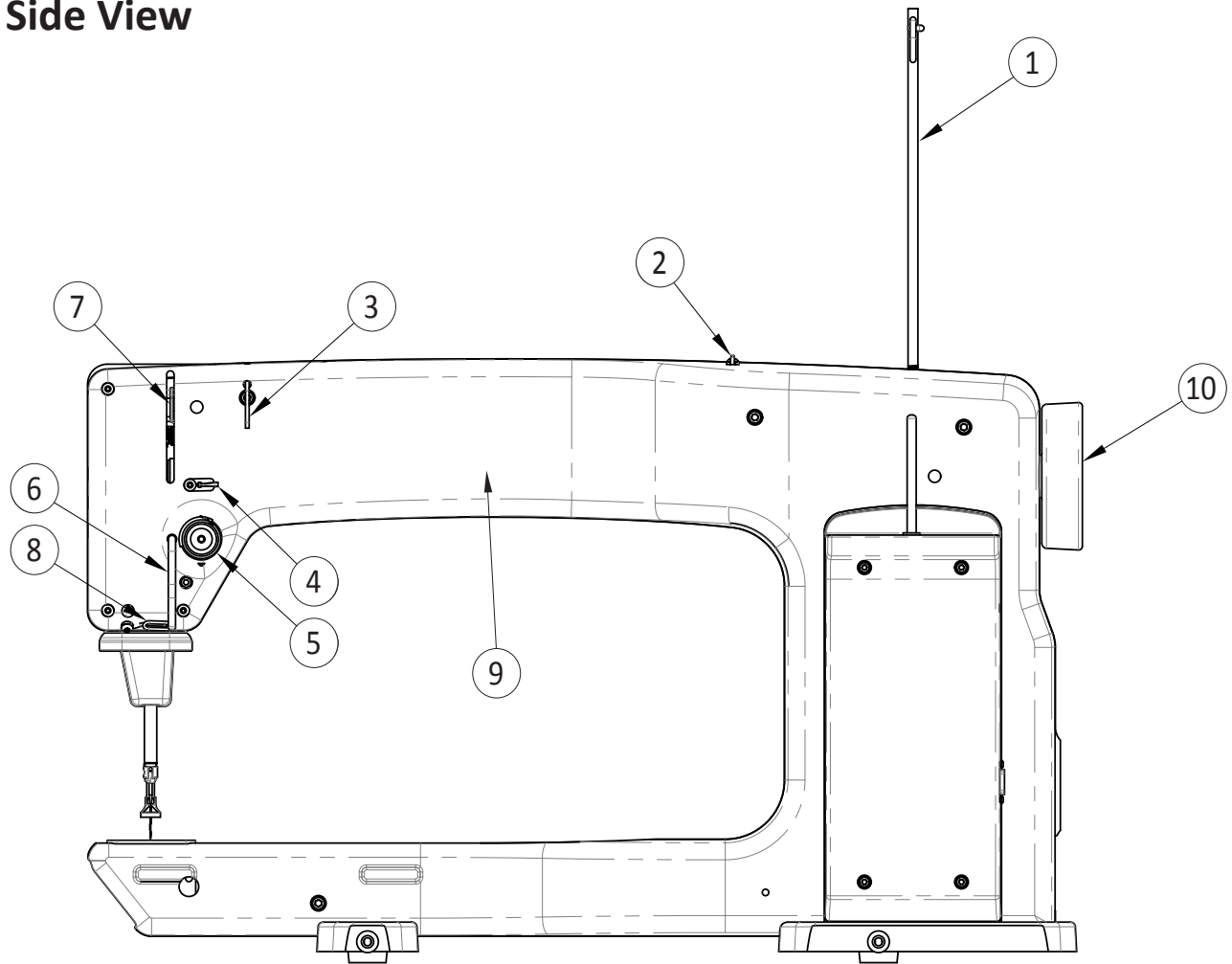

Figure 1

1. Thread Mast
2. Thread Guide A
3. Three-Hole Thread Guide B
4. Thread Guide C
5. Top Thread Tension Assembly
6. Stirrup Thread Guide E
7. Take-Up Lever
8. Thread Guide F
9. Front Casing/Frame
10. Hand Wheel

Components Not Identified

Because the HQ Sweet Sixteen is upgradeable to a stand-up frame quilting system, there are components found on the machine that are not used for sit-down machine quilting (such as threaded holes for handlebars).

Back Side View

- 11. Needle Bar
- 12. Needle Bar Thread Guide
- 13. Needle
- 14. Closed-toe foot
- 15. Needle Plate
- 16. Handi Feet mount
- 17. Presser Bar
- 18. Front Threaded Display Mounting Holes
- 19. Front Base
- 20. Back Casing/Frame
- 21. Rear Base
- 22. Color Touch-Screen Display Connector
- 23. Threaded Horizontal Spool Pin Mounting Hole

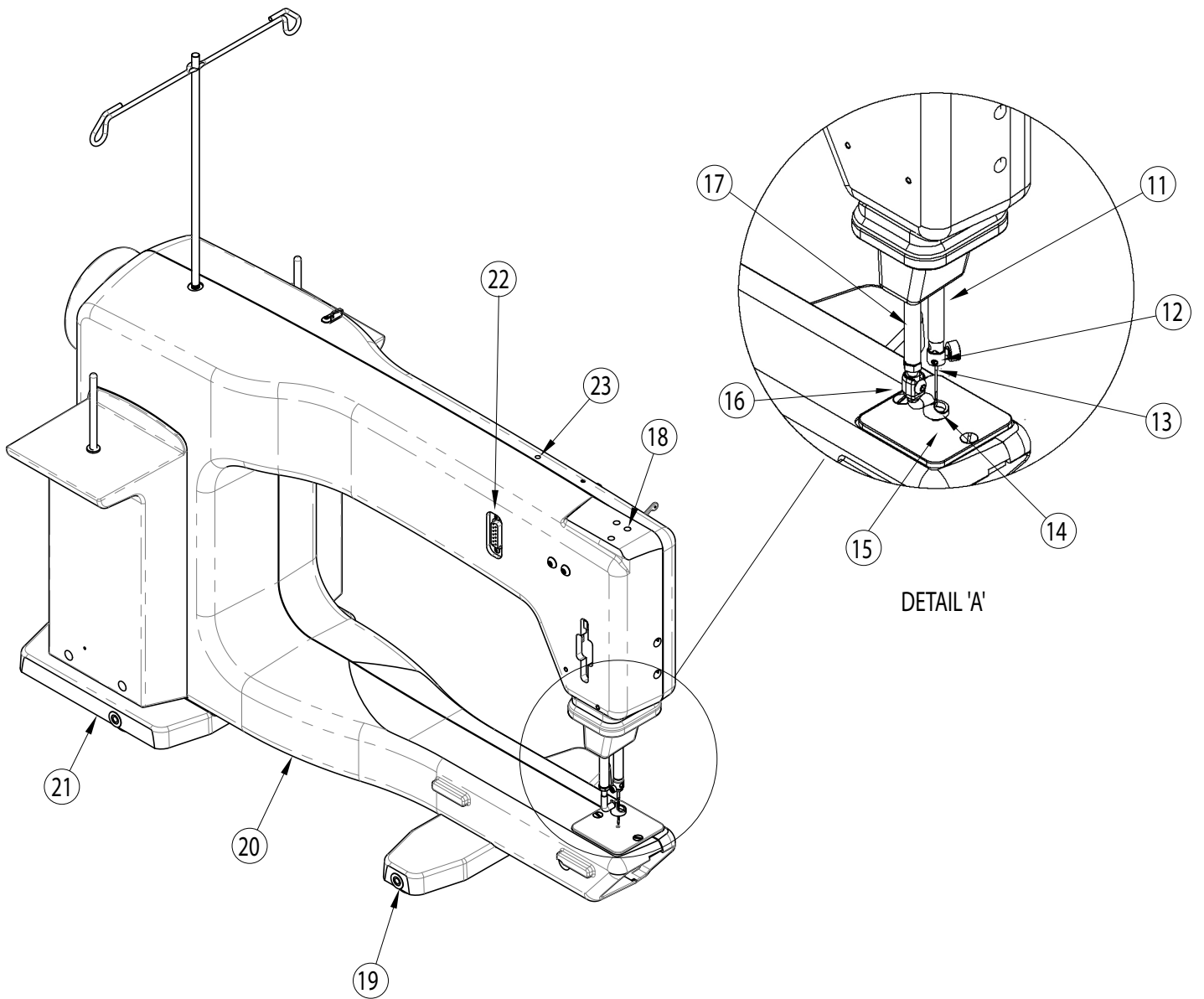

Figure 2

Rear and Front Views

- 24. On/Off Switch
- 25. Power Cord Connector
- 26. Accessory Power Outlet
- 27. Foot Pedal Connector
- 28. Spool Pin 1

- 29. Electronic Control Pod (C-Pod)
- 30. Bobbin Assembly
- 31. LED Light Ring
- 32. Power Pod (P-Pod)
- 33. Spool Pin 2

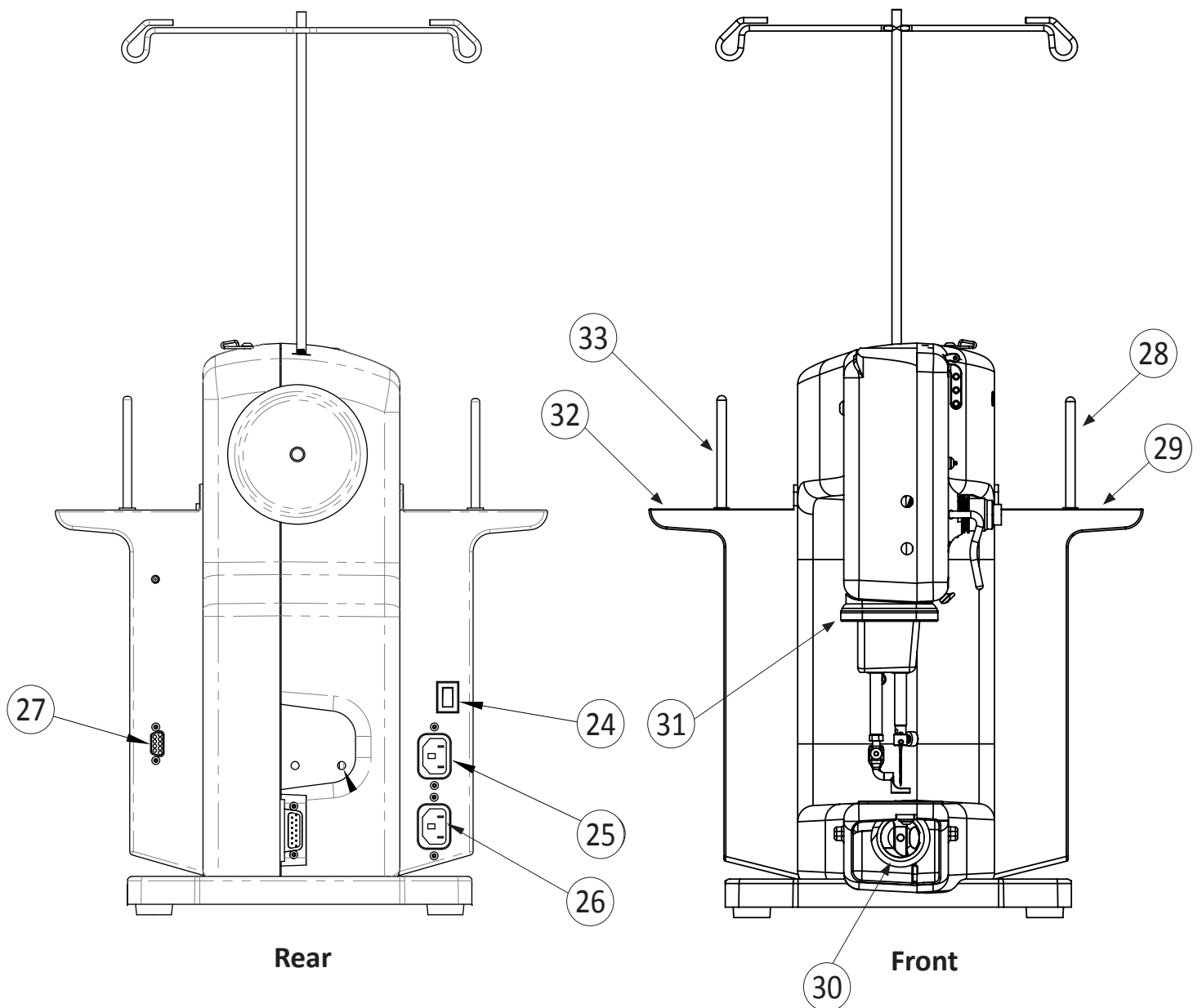

Figure 3

Setting Up the Table (and Taking it Down for Storage)

The HQ Sweet Sixteen table has been designed to accommodate the HQ Sweet Sixteen machine. It has folding legs that are height-adjustable and is heavy enough to provide stabilization for quilting at high speeds.

1. Open the box and gently remove the table, taking care not to drop the table on the floor. The table weighs nearly 50 pounds, so it is recommended that you ask someone to help.
2. Unfold the legs, pulling on the horizontal braces until the legs snap into place. Set the table upright.
3. Make the table taller by pinching the two height-adjustment tabs on each set of legs and lifting on table, while holding legs down with foot. Make the table shorter by pinching the same tabs and pushing down on the table.
4. To store the table, remove machine and return legs to their lowest position.
5. The legs are attached to the table top with brackets of two different sizes. One is longer than the other. Identify the long and the short leg brackets.
6. Fold in the short bracket leg first. Push on the horizontal braces to loosen the legs and push them back toward the table top.
7. Repeat with the long bracket leg.

Placing the Machine in the Table

1. We recommend having someone help lift and place the machine.
2. Lift the machine by putting one arm through the throat space.
3. Guide the machine from the back of the table into the slot. Machine is positioned correctly when the back of the machine is flush with the back of the table.

Installing the Power Cord



Figure 4

Check that the On/Off switch (page 11, Figure 3, #23) is turned off (the 0 setting). Plug the power cord into the top power outlet on the back of the machine (Figure 4). Do not plug the power cord into a power source at this time.

The lower power connector is available for powering future attachments as they are developed by Handi Quilter. (Not yet available.)

Installing the Foot Pedal

1. Plug in the foot pedal cord end into the foot pedal connector (see page 11, Figure 3, #26).
2. Place the foot pedal under the table where operator can reach it from the front of the machine.

Installing the Thread Mast



Figure 5

1. Locate the threaded hole on top of the machine near the rear by the hand wheel.
2. The thread mast comes with a washer and a nut. Remove the nut and washer, replace the nut onto the mast for two or three turns.
3. The washer protects the painted surface when the nut is tightened. Place the washer on the hole and insert the thread mast.
4. Turn the thread mast clockwise several revolutions, stopping when the mast eyelets are positioned directly over the spool pins.
5. Tighten the nut to secure the mast to the machine.

 **NOTE:** The eyelets of the thread mast **MUST** be centered over the spool pins. This ensures that the cone of thread will not pull, turn or tilt, which will cause thread tension problems (see **Figure 5**).

Installing the Color Touchscreen



Figure 6

The color touchscreen comes pre-installed on its mounting bracket and should have one end of the D cable attached to the back of the touchscreen (see **Figure 6**).

 **NOTE:** Confirm that the power is turned off before installing the Color Touchscreen.

1. Remove the two long bolts from the bag in which they are packed.
2. There are three holes on top of the machine head (see **page 10, Figure 2, #18**). Only the two holes that are in line with each other are used. Ignore the third hole located to the side of these two holes.
3. Align the holes in the color touch-screen bracket with the two holes on top of the machine, with the touch-screen facing the needle end of the machine.
4. Use a 5 mm Allen wrench to insert the two long bolts through the holes of the bracket and into the machine (**Figure 6**). Tighten in place.
5. Plug the remaining cable end into the display connector located on the side of the machine (**page 10, Figure 2, #22**).
6. Remove the protective plastic from the touch-screen before using.

Inserting (or Changing) the Needle

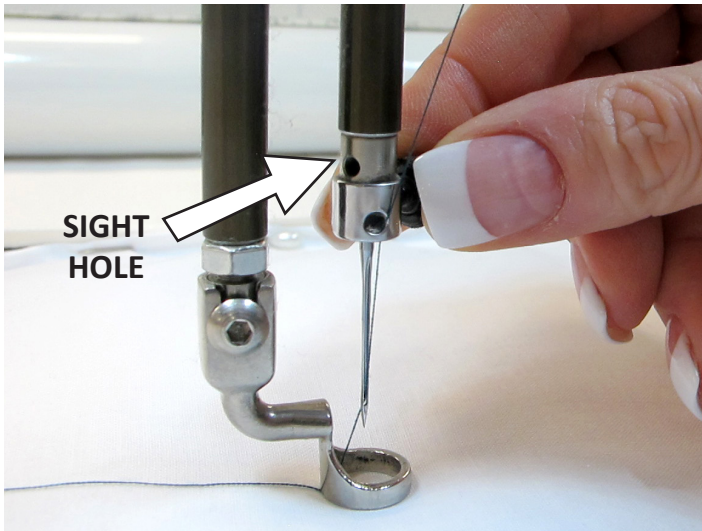



Figure 7

The needle that is in the machine when it arrives at your home has been used for 20 minutes of testing. It is possible that it could be damaged in shipping or as you remove the machine from the box. For these reasons, Handi Quilter recommends that you replace the needle before beginning to quilt with your new machine.

1. Move the needle bar to the highest position by turning the front or rear hand wheel or pressing the needle up/down control on the handles. Then turn off the power.
2. Loosen the needle-bar-clamp thumb-screw
3. Remove the old needle by pulling it down. Discard the old needle in a safe way.
4. With the scarf (small ground out section/dip on the back side of the needle just above the needle eye) facing toward the back hand-wheel side of the machine, and the long groove down the front of the needle facing the bobbin case side (figure 7), push the needle all the way up into the needlebar, until it can go no farther.
5. Carefully tighten the needle bar clamp screw until the needle is securely fastened into the machine. If necessary use the 2.5mm hex tool to secure the needle; however take care not to over tighten the screw. This may result in damaged or stripped threads in the needle clamp. Damage to the needle clamp may also make it difficult to fully insert the needle, which will change the machine timing causing more issues. Stripped threads and damage caused by improper needle installation or tightening are not covered under warranty.

 **NOTE:** It is recommended to use a new needle for each new quilt. Also, replace the needle any time it becomes bent, dull or burred.

🕒 **IMPORTANT:** Check the needle to confirm it is fully inserted. The needle bar has a stop/sight hole above the needle bar clamp screw. Make sure the needle is touching the top of the stop/sight hole. If it is not, the machine timing will be off and it may be possible for the needle to collide with internal parts, causing damage not covered by warranty.

⚠️ **CAUTION:** Your Handi Quilter machine stitches at a much faster speed than your home sewing machine, therefore, it is essential that the needle is seated into the needle bar and fully tightened (but not over tightened). Check often that the needle has not become loose. If the needle comes loose, it could break in the machine causing damage, alter the machine's timing, or cause bodily harm.

Needles are inexpensive and are important to the success of your project. Plan to change needles every 5-7 hours of quilting or more often if working with a lot of fusibles or heavy materials.

Needle/Thread Selection Guide

Needle Size	Threads
12 (80)	Monofilament, 100 wt. Silk, 60 wt. poly, mylar
14 (90)	Silk (100 wt) 60 wt., monofilament, glitter, some metallics
16 (100)	60 wt., 50 wt., 40 wt., monofilament, glitter, metallics
18 (110)	50 wt., 40 wt., 30 wt., metallic
20 (120)	30 wt., 20 wt., 12 wt.

Changing the Hopping Feet

Your machine comes with two hopping feet: a closed-toe foot and an open-toe foot. Use the closed-toe foot for ruler work and everyday quilting, and the open-toe foot when you need greater stitch visibility (such as micro quilting).

1. Remove the foot that is on the mount by using the 2.5mm Allen wrench to loosen the mounting screw far enough that you can slide the foot off of the mount.



Figure 8

2. Slide the desired foot onto the mount (figure 8). Note that the opening on the side of the foot is lined up with the screw hole. Push the foot up as far as it will go.



Figure 9

3. Ensure the middle of the foot opening is centered with the needle when the foot is fully tightened with the 2.5mm Allen wrench. If it isn't properly centered, loosen the lock nut; center the foot with the needle; hold the foot in position; and firmly tighten the lock nut (Figure 9).

Threading the Machine

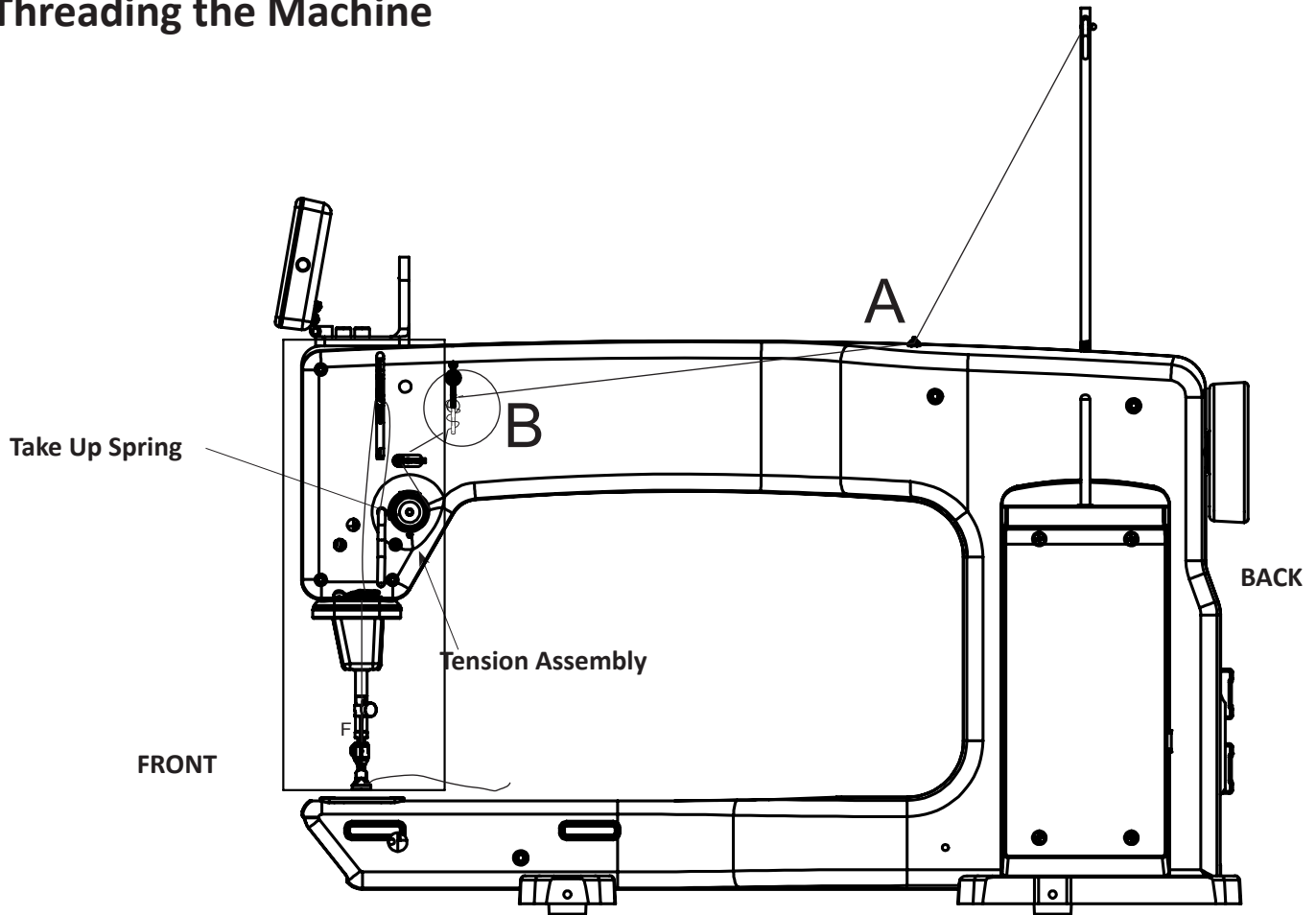

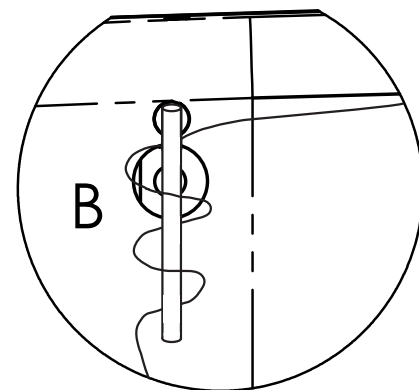

Figure 11

1. Place a cone or spool of thread on the spool pin. If using a spool, make sure that the slits on the spool are against the base of the spool pin holder. Pass the thread through **the thread-mast** eyelet from back to front, continuing to thread guide **A**. (Figure 10)
2. Continue to the three-hole thread guide **B**. Beginning at the top, wrap all three holes from back to front, hand wheel side to needle side (see Figure 11).

 **NOTE:** The purpose of the three-hole thread guide **B** is to prevent loops of thread coming off the thread cone from going into the top tension as a knot causing thread breakage and bad tension. For most threads on a cone, it is important to thread all three holes for consistent results and to make adjustments at the top tension assembly. An exception to this rule is when working with very delicate threads, such as holographic or threads that are prone to breakage. You may try skipping one or two holes on thread guide **B** when using these threads.



DETAIL 1

Figure 10

 **NOTE:** See “HQ Quilting Machines Getting Started” DVD (included with your machine) for videos showing threading and other tips. These videos are also available on www.HandiQuilter.com.

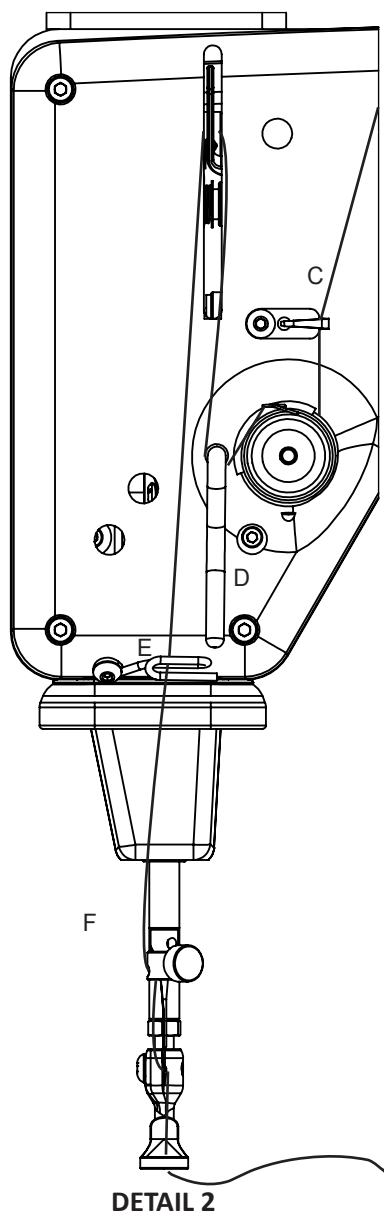

Figure 12

3. Thread continues through thread guide **C**, and then down to the **tension assembly** (see Figure 12).

NOTE: It is important that the thread is “flossed” up between the two tension discs. If the thread is not firmly in place between the two tension discs, the thread rests on the outside of the tension discs (without tension) and looping on fabric or thread nests may occur.

4. Once the thread is in place, be sure that the thread catches on the take-up spring and then pull it down under the stirrup (thread guide **D**).

5. Bring the thread back up through the take-up lever from back to front, and then down through thread guide **E**. Pull the thread at the take-up lever to ensure that it is properly flossed between the tension disks. If it is properly flossed in the tension disks you should feel some resistance as you pull the thread. If it is not, then the thread will pull freely.

6. Pull the thread down to the needle thread guide and thread through the hole (thread guide **F**).

7. Make sure the thread is following the groove down the front of the needle and threads from front to back. Be careful that the thread does not twist around the needle.

IMPORTANT: The HQ Sweet Sixteen quilting machine does not have a presser foot lever or top tension release like a home sewing machine. On a home sewing machine the top tension is released when the presser foot is raised, allowing the thread to come freely out of the machine. When a home machine is threaded, the presser foot is raised and the tension discs are released and open for the thread to easily fall between the tension discs. This is not the case with the HQ Sweet Sixteen quilting machine where the top tension is always tight and the tension discs are never open. Therefore, the thread must be pulled up or “flossed” between the tension discs or it will stay outside the discs and float without tension, causing serious stitch problems and/or thread nests. It is also possible to bend the needle while it is threaded if care is not taken while moving the machine around the quilt because the top tension is never released.

Bobbin and Thread Tension Adjustments

Inserting the Bobbin

 **NOTE:** Turn off the power switch while inserting the bobbin case or anytime your hands are near the needle area.

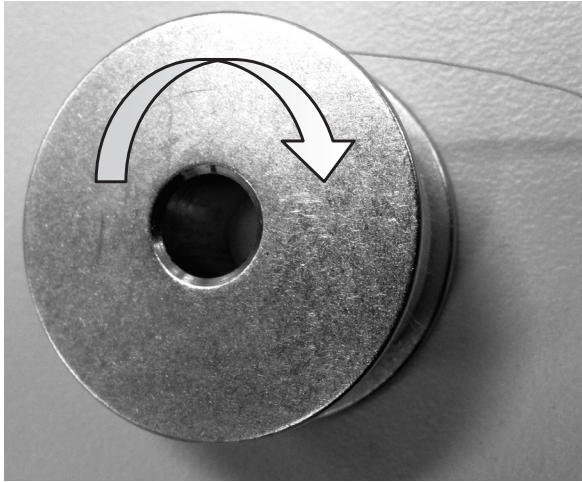

Figure 13

1. Place the bobbin in the bobbin case so that the thread pulls off clockwise when viewing the open side (Figure 13).

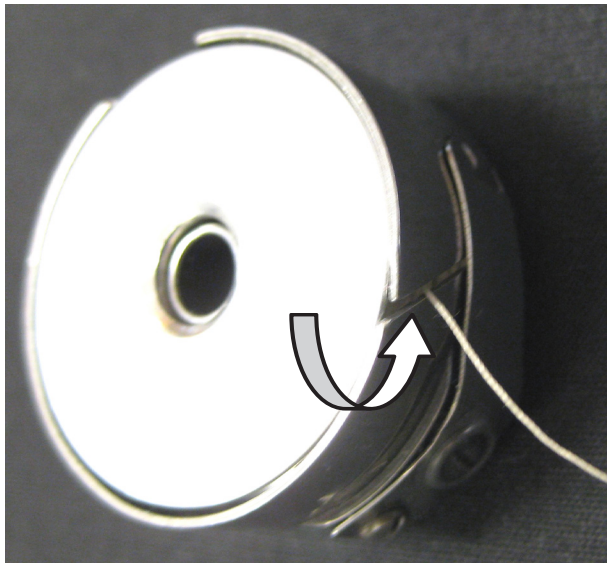

Figure 14

2. Slide the thread through the slot (Figure 14) and under the tension spring leaving 5-6 inches of thread hanging loose (Figures 14 and 15).





Figure 15



Figure 16

3. To insert the bobbin case into the machine, grasp the bobbin case with thumb and first finger. Do not lift the lever on bobbin case. Fit the bobbin case onto the hook spindle in the machine. Rotate the case until the open throat keys into the alignment notch in the middle of the hook. Push the case in until it stops in place. Push the case inward further until it clicks (see Figure 16). Allow the thread end to hang freely.

 **NOTE:** Pulling out the latch lever pushes the bobbin forward in the bobbin case, aiding in removal of the bobbin. The lever should be used only for removing the bobbin case from the machine.

 **NOTE:** See “HQ Quilting Machines Getting Started” DVD (included with your machine) for videos showing adjusting bobbin tension and other tips. These videos are also available on www.HandiQuilter.com.

Drawing the Bobbin Thread to the Top of the Quilt

1. After threading the machine, plug it in and turn on the power. Place quilt sandwich under hopping foot.
2. While firmly holding the tail of the needle thread with the left hand, choose one of the following methods to cycle the needle through one full rotation to bring the bobbin thread to the top of the quilt.
 - A. Foot Pedal Method. LIGHTLY tap the foot pedal to make the needle go down. Then LIGHTLY tap again to bring the needle up.
 - B. Needle Up/Down Button Half-Stitch. Find the Needle Up/Down Button in the center of the color touch-screen main display. Press once to cycle the needle down. Press again to cycle the needle back up.
 - C. Needle Up/Down Button, Full-Stitch. Find the Needle Up/Down Button in the center of the color touch-screen main display. Press and hold briefly to cycle the needle through one complete stitch cycle (down and back up).
3. Pull the fabric 3-4 inches away while holding the needle thread.
4. Bobbin thread will pull up and through to the top, allowing you to grasp the loop and pull it to the desired length.

Checking and Adjusting Bobbin Case Tension

The bobbin case tension is the foundation tension for the entire machine. To test that bobbin tension is correct, hold the bobbin case in the palm of your hand with the open end facing up. Wrap the thread around your index finger and lift the bobbin case from your hand. While gently moving the finger front to back (not up and down, which is not consistent), the bobbin case should slide slowly down the thread, like a spider on its web.

The small screw in the center of the tension spring is where the adjustment is made (see Figure 17). Turn clockwise to tighten and counter-clockwise to loosen the bobbin case tension. Make very small adjustments. **Check the bobbin tension every time a new bobbin is inserted.**



Figure 17

Tighten Bobbin Case Tension

The bobbin case tension is **TOO LOOSE** if it will not lift up onto its side. Turn screw clockwise to tighten. The bobbin case screw requires very small adjustments. Think of the “tick of a clock”. Adjust, then check. Adjust and check again.

Loosen Bobbin Case Tension

The bobbin case tension is **TOO TIGHT** if it lifts out of your hand. Turn screw counterclockwise to loosen. The bobbin case screw requires very small adjustments. Think of the ticks of a clock. Adjust, then check. Adjust and check again.

Easy-Set Tension™ Adjustment

- **IMPORTANT:** Top thread tension should be adjusted only after the bobbin case foundation tension adjustment is made.

Puckering, gathers and thread breakage occur when the top tension is too tight. Loops and thread nests occur on the back when the top thread tension is too loose. (See Figure 18 on next page.) Tension may need to be adjusted, depending on the fabric, thread or batting used in each project.

As you change the top tension, the value in the tension indicator box on the Main screen increases or decreases in increments of five. When you are happy with the tension, note the top tension value for that type of thread (brand, weight, and color) so you can quickly and easily set the tension when you use this thread again in the future.

Unlike the bobbin case adjustment, which requires minute adjustments, the top tension knob may require turns anywhere from 1/4 of a turn to two to four turns to achieve balanced tension.

Tighten Top Thread Tension

To adjust the top tension tighter, turn the top thread tension knob (page 9, Figure 1, #5) **clockwise**.

Loosen Top Thread Tension

To loosen the tension, turn the top thread tension knob (page 9, Figure 1, #5) **counter-clockwise**.

 **NOTE:** Before adjusting the top tension, remember to floss or pull the top thread up into the tension discs or it will float outside the discs providing little or no top tension. This could cause significant tension or nesting problems on the bottom side of the quilt. If the top tension is too loose (causing loops of thread on the underside of the quilt) and no amount of tightening the top thread tension knob seems to affect it, there's a good chance that the thread is riding on the outside of the tension discs and is not "flossed" between them.

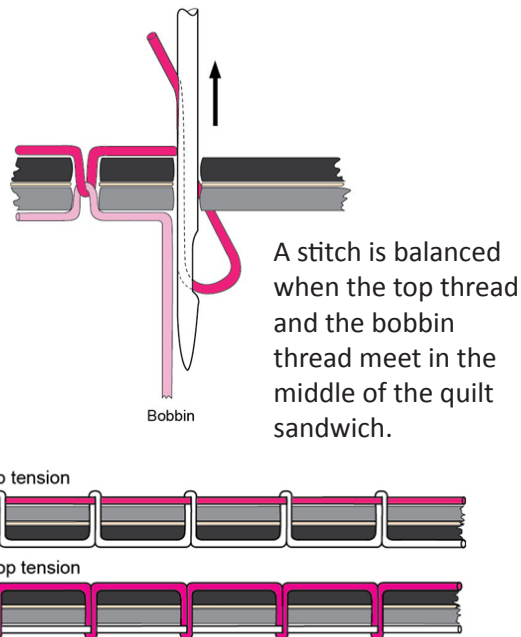



Figure 18

Maintenance

 **NOTE:** Turn off the machine and remove the power cord when performing maintenance on the machine.

Cleaning and Lubricating the Machine

Only use light sewing machine oil in the HQ Sweet Sixteen. Internal oiling is not necessary on the HQ Sweet Sixteen except when the machine is taken to a service technician

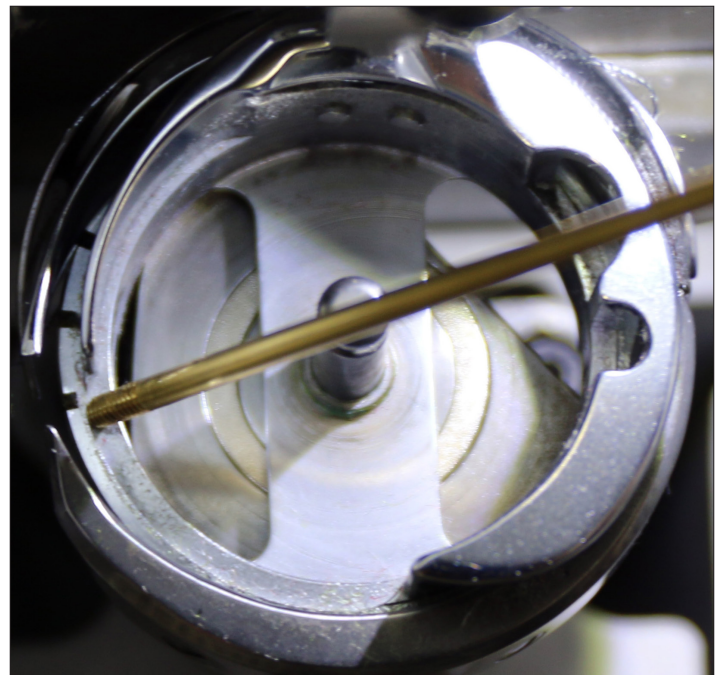

Figure 19

for routine maintenance and cleaning. The hook assembly, however, needs regular lubricating. Failure to keep the hook assembly lubricated can cause severe damage to the machine.

To lubricate, turn off the machine. Remove the bobbin and case before oiling. Clean around the hook assembly with a soft brush to remove lint. Put a very small drop of oil on the hook in the region where the bobbin basket assembly and the rotating hook meet (see Figure 19). The bobbin basket is the portion of the hook that the bobbin case snaps into. The bobbin basket remains stationary while the hook rotates around the basket. The oil lubricates the region where these two components interlock. A drop of oil in the region indicated will work its way back into the interlocking area of the hook and bobbin basket.

The frequency of lubrication depends upon the usage of the machine. Lubricating is recommended before running the machine if it has not been used regularly, or every other bobbin change if used frequently. After oiling, always stitch through a scrap piece of fabric, as oil may cling to thread. Over-oiling can cause excess dripping from the bobbin assembly. Lack of lubricant may be noticed by a change in the sound of the machine and will affect stitch quality.

Cleaning the Touch-Screen Display

Use a soft rag dampened with isopropyl alcohol to gently wipe the display and remove any marks. Never use any other chemicals to clean your display as they may adversely affect the touch-screen response and clarity.

Using the Touch-Screen Display

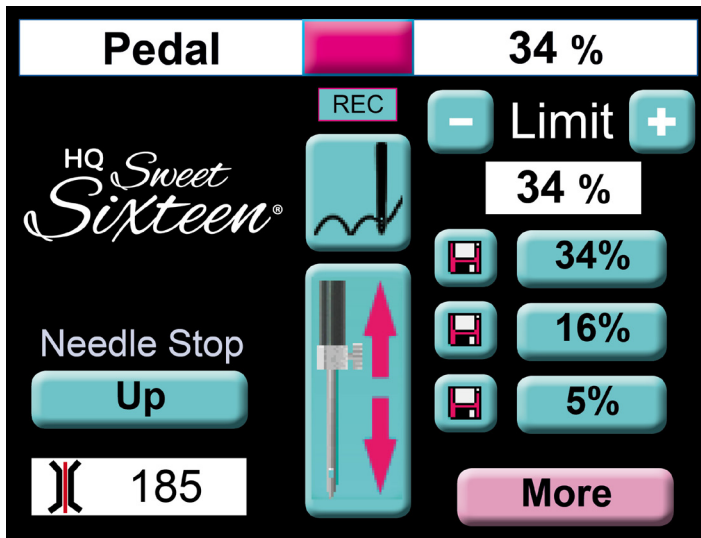

Figure 20



Figure 21

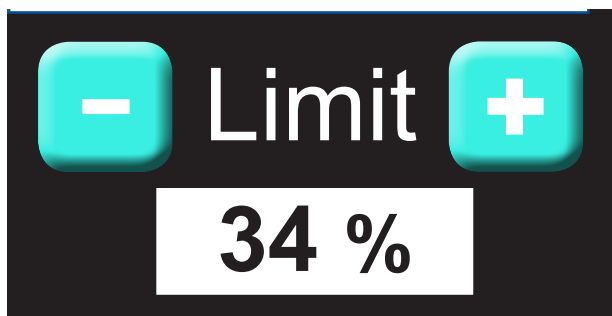

Figure 22

NOTE: Review the Handi Quilter “Getting Started” DVDs for interactive instruction on the HQ Sweet Sixteen menu functions.

The HQ Sweet Sixteen has a color touch-screen display on the front of the machine. Settings are changed using this display.

Main Screen Button Functions (Figure 20)

Pedal Status

The status of the foot pedal connection is displayed in the top left corner of the Main screen (Figure 20). If the foot pedal is not properly connected the message “Check Pedal” will appear in red letters. Once the pedal is connected properly the word “Pedal” appears in that space in black letters.

On/Off Indicator

The box in the center of Figure 21 indicates whether or not the motor is running. It will be red when the machine is stopped and green when the foot pedal is pressed.

Current Speed

The box in the top right of Figure 21 is the current percentage of full speed the machine is running. The value displayed will vary as you press and release the foot pedal. The maximum percentage value that is displayed is controlled by the Limit that is set for the machine.

Limit Controls

The Limit box encompasses two main features, the “My Speed” controls and Preset buttons. The My Speed controls consist of “+” and “-” buttons and the white My Speed display box (Figure 22). Pressing the “+” button will increase the maximum motor speed the pedal controls. Pressing the “-” button will decrease the maximum speed.

The My Speed range is between 5 % and 100 % or between 75 and 1500 stitches per minute (SPM). The current percentage My Speed value is displayed in the white box under the “Limit” text. This My Speed setting will be preserved when the machine is shut off, allowing you to begin quilting again at the same speed when you turn the machine back on.

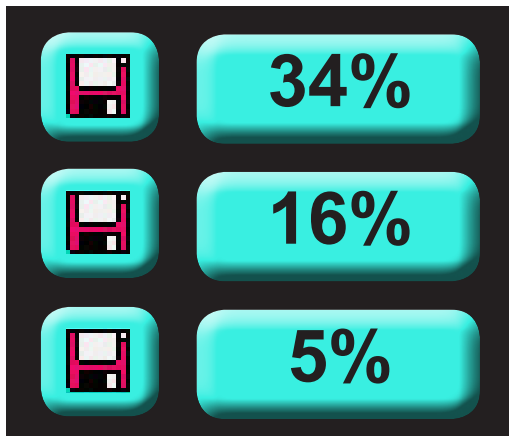

Figure 23

Presets

Save up to three preset speeds to quickly switch between speed preferences. For example, you may prefer a slower speed when using rulers and a faster speed when doing all-over meandering quilting. (Figure 23)

Use the “+” and “-” buttons to adjust the speed percentage and then press the record button next to one of the preset values to store that speed as a preset. When you want to use one of the preset speeds, simply press the speed.

Basting Mode

The HQ Sweet Sixteen has a basting mode that causes a stitch to be formed at a specified time interval – every half second, every three-quarters of a second, every second, every 1.5 second, or every two seconds. (Figure 24)

Touch the basting icon (Figure 25) to activate basting mode. Then press the “+” or “-” button to set the time interval for the basting stitch.

Press the foot pedal to begin quilting. The HQ Sweet Sixteen will take a stitch (needle down and then needle up) at the specified interval. Coordinate how quickly you move the quilt sandwich with how quickly the machine takes a basting stitch. Experiment with the various speed options along with moving the quilt to find which of the settings work best for you to position the basting stitches on your quilt.

Easy-Set Tension

The tension box (Figure 26) on the Main Screen shows the current tension setting as a numeric value. As you turn the tension dial clockwise to tighten the top tension, the number increases in increments of five. As you turn the tension dial counterclockwise to loosen the top tension, the number decreases in increments of five. The faster you turn the dial, the faster the numbers increase or decrease.

After setting the bobbin tension, test the top tension by stitching on a fabric scrap on the edge of the quilt batting and backing. Increase or decrease as needed until you have achieved balanced tension. Make a note of the type of thread (weight, brand, color) you’re using and the tension value. You will be able to quickly and easily set the tension when you use this same thread again in the future.

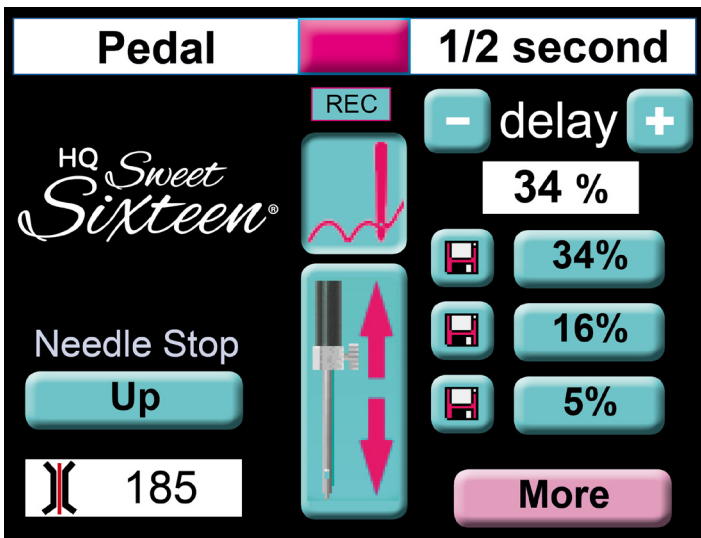

Figure 24

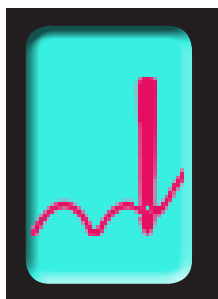

Figure 25

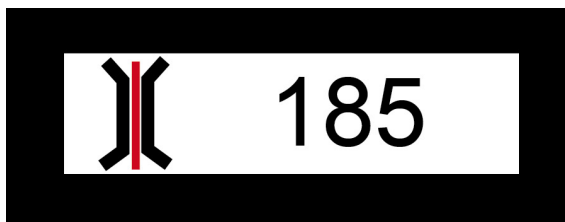

Figure 26

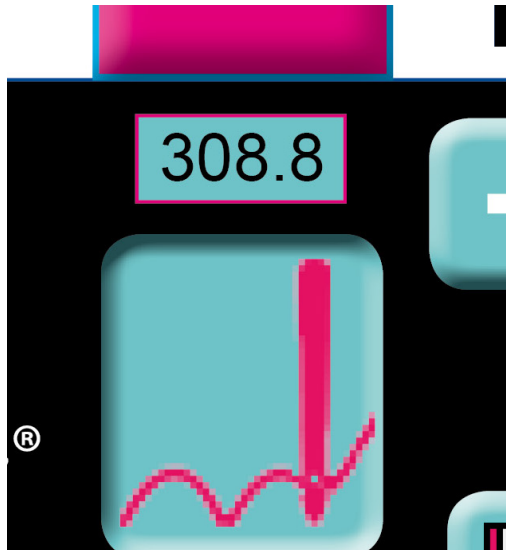

Figure 27

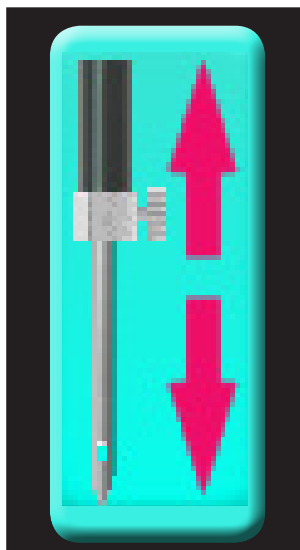

Figure 28

Bobbin Thread Indicator

If you use the Low-Bobbin Estimator feature, The Bobbin Thread Indicator box (Figure 27) shows how much bobbin thread remains on the bobbin. The value counts down until it gets to zero, at which time the low-bobbin alarm alerts you that it is time to put in a new bobbin. While the machine is recording how much thread is on a bobbin, REC appears on the screen to remind you that it is estimating the bobbin capacity.

Up/Down/TieOff

The button with the needle image in the center of the screen can assist you in creating tieoff stitches, basting or needle-positioning functions without the use of the foot pedal (Figure 28). Pressing and releasing the button quickly will send the needle to the next needle stop position. If the needle is up, pressing the button will cause the needle to move to the down position. If the needle is down, it will return to the up position.

Pressing and holding the button for a longer time allows you to do a full stitch. As long as you continue to hold the button down the machine will continue to stitch at a slow rate, and when the button is released the needle will stop in the closest stop position (up or down) available. This action is useful for tying off beginning and ending stitches.



Figure 29



Figure 30

Needle Stop

The Needle Stop setting enables you to specify whether you want the needle to end in the up or down position when you stop quilting. If you select Down, when you release the foot pedal the needle ends in the down position. If you select Up, the needle ends in the up position when you release the foot pedal. Switch between the up and down position by pressing the Needle Stop button (Figure 29).

More Menu (Figure 31)

The More menu allows access to other functions available on the HQ Sweet Sixteen.

Low Bobbin

The HQ Sweet Sixteen includes a low bobbin alarm so you can estimate how soon your bobbin thread will run out.

Timers

The HQ Sweet Sixteen has two useful timers. One timer enables you to set a reminder alarm (like a kitchen timer) and the other timer tracks how much time you spend on a quilt project.

Options

Pressing the "Options" button will open a screen that allows adjustment of the sound volume and the LED Light Ring brightness.

Calculator

An on-screen calculator may be accessed from the "More" screen.

System Information

The "Sys. Info." Button provides access to machine information. This includes the machine Serial Number, the hardware and firmware version numbers and the Stitch Counters.

Diagnostics

The "Diagnostics" button activates the screen where machine diagnostic functions can be performed. Diagnostic functions are generally only used when working with your authorized Handi Quilter retailer to resolve issues.

Set Language

The HQ Sweet Sixteen screens can appear in English, French, German, or Spanish. On the More Screen, press the lower-left button to cycle between English, Français, Deutsch, and Español. After selecting your preferred language, press Main to return to the Main Screen.

Main

Press the "Main" button to return to the Main menu screen.

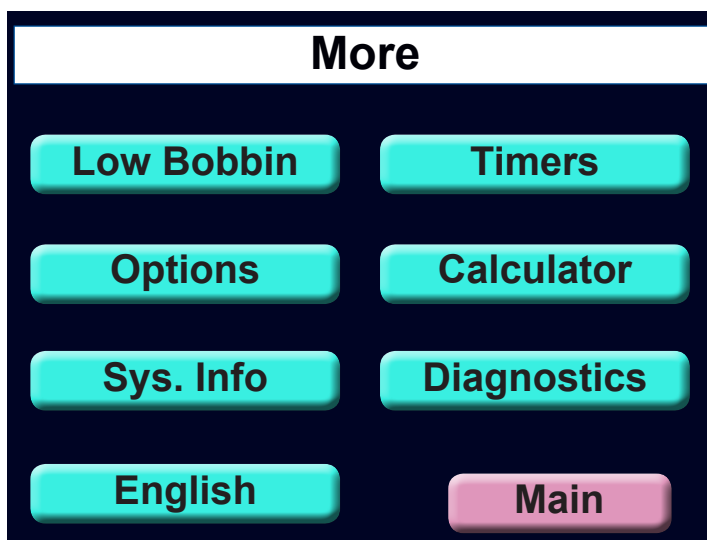

Figure 31

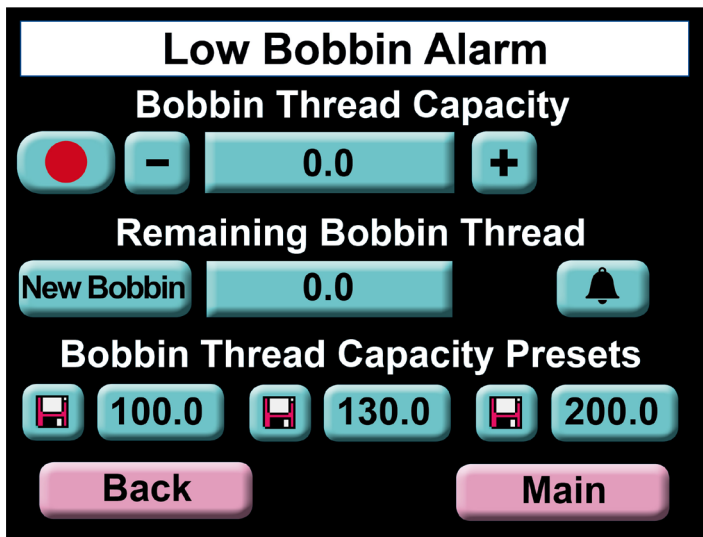

Figure 32

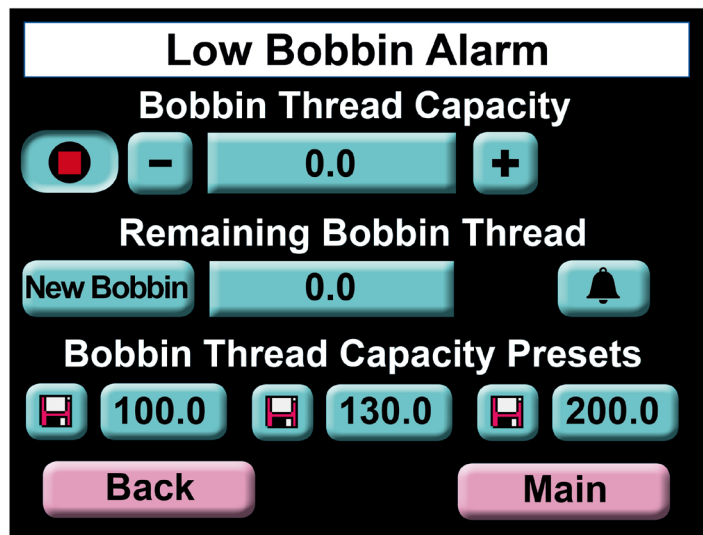

Figure 33

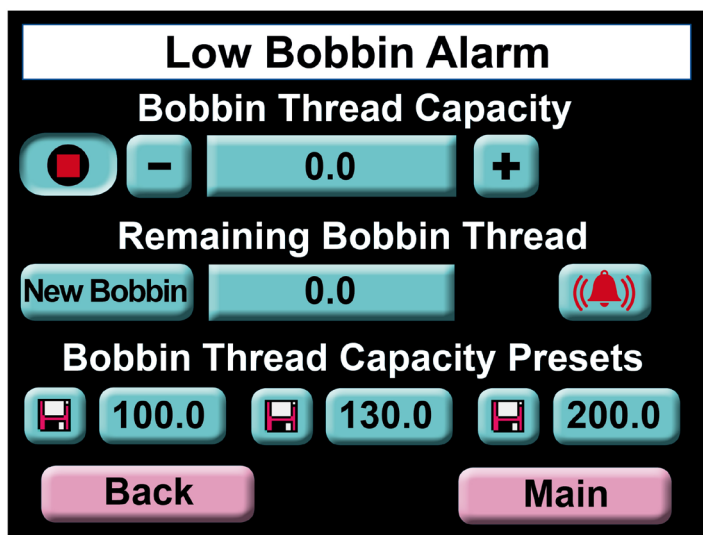

Figure 34

Low Bobbin

The HQ Sweet Sixteen includes a low bobbin alarm so you can estimate how soon your bobbin thread will run out. This Low Bobbin Capacity is based on an estimate of how much of a particular thread can fit on a bobbin, in combination with other quilting factors such as tension, stitches per inch, and how much bobbin thread you pull up when beginning and ending your quilting (Figure 32).

To estimate how much thread is on a bobbin, place a full bobbin in the machine and under the heading Bobbin Thread Capacity, press the Record button and quilt as usual.

When the bobbin runs out, press the square Stop Recording button and note the number that is indicated under the Bobbin Thread Capacity (Figure 33), perhaps 210 yards. Since you want a warning as to when the bobbin is getting low, use the “-” button to specify a lower number, such as 195. Save that as one of the Bobbin Thread Capacity Presets. You might want to make a note as to which type of thread the preset represents. Put a new bobbin with the same thread into the machine and press the New Bobbin button. Then press the Alarm button. As you quilt, the remaining bobbin thread value will estimate how much thread remains on the current bobbin, and when you reach the capacity value, an alarm will sound warning you that your bobbin is nearly out of thread (Figure 34).

When recording the capacity of a bobbin, the HQ Sweet Sixteen assumes you will stitch at 10 stitches per inch if TruStitch stitch regulation (optional accessory) is not attached to your machine. Therefore, if you estimate bobbin capacity and stitch using different stitches per inch, increase the capacity setting (if stitching fewer than 10 stitches per inch) or decrease it (if stitching more than 10 stitches per inch).

If TruStitch is attached and powered on, the low-bobbin capacity calculation uses the current last TruStitch stitches-per-inch setting to calculate bobbin capacity when you are stitching in regulated mode. In Manual mode the last stitches-per-inch setting used in regulated mode is used to calculate the bobbin usage.

You can store three Bobbin Thread Capacity preset values – one for each of three different types of thread. Simply go through the record process with a full bobbin of that type of thread and then store the capacity as a preset. When you switch to using that type of thread, press appropriate preset button. Insert a full bobbin with that type of thread, press New Bobbin, and all of the settings will be based on that type of thread.

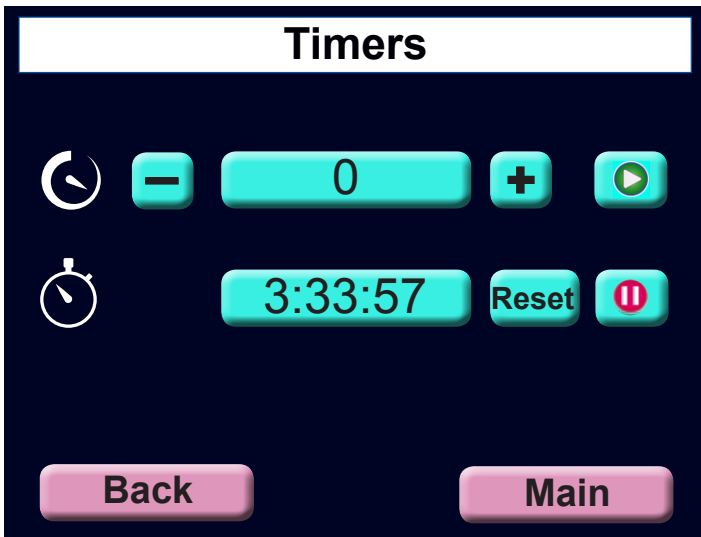

Figure 35

Timers

The HQ Sweet Sixteen has two useful timers. One timer enables you to set a reminder alarm (like a kitchen timer) and the other timer tracks how much time you spend on a quilt.

The first (top) timer is a reminder timer. It enables you to set an alarm to go off after a specific period of time, similar to a kitchen timer. Use the “+” and “-” buttons to set the time duration. Then press the “play” button to activate the timer. When the time duration has elapsed, an alarm will sound and a message appears on the display.

The second (bottom) timer enables you to track how much time you spend on a quilt project. When you begin a new project, press the Reset button. Then press the “play” button to begin recording your quilting time. The timer records when the machine is quilting. The time is saved even when the machine is turned off. When you begin another quilting session, quilting time is added to the timer. Only press Reset when you want to zero-out the timer and begin a new timing session. (Figure 35).



Figure 36

Options Screen

Volume

The Volume portion of this screen (Figure 36) has two buttons and a sliding control. Pressing on the “Mute” button turns off the sound of the buttons when they are pressed. Pressing the “Max” button turns the volume to its loudest level. Pressing the sliding control in any position sets the volume to the level indicated in that control. Pressing and moving back and forth across the sliding control will change the volume up as it is moved left to right and down as it is moved from right to left .

Brightness

The “Brightness” portion of this screen has two buttons and a sliding control as well. The LED Light Ring can be turned on completely with the illuminated light bulb button or off completely with the darkened light bulb button. Pressing the sliding control in any position will set the brightness to the value indicated in the slider control. Pressing and moving back and forth across the sliding control will change the brightness up as it is moved left to right and down as it is moved right to left.

Press the “Main” button to return to Main menu screen or the “Back” button to return to the “More” menu screen.

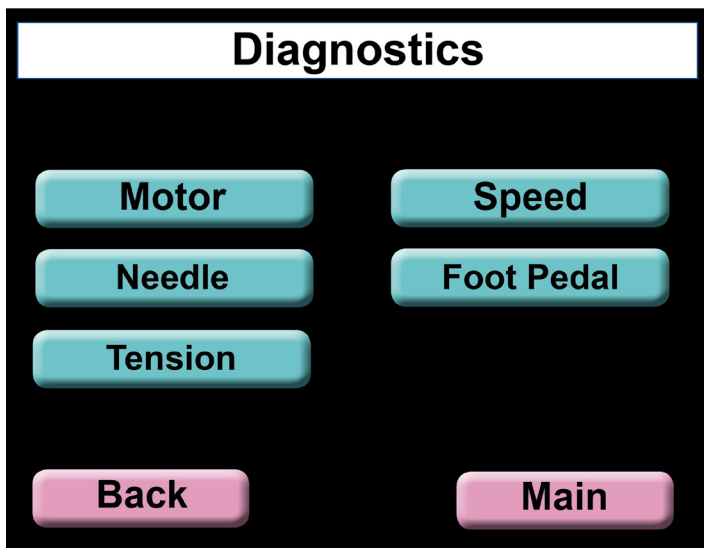

Figure 37

Diagnostics Screen

Four different diagnostics tests can be performed on the machine. These functions test the motor control operation, the foot pedal and the internal position sensors. (Figure 37)

Press the "Main" button to return to the "Main" menu screen or the "Back" button to return to the "More" menu screen.

Diagnostics Tests

Motor Sensor Test

The "Motor" Sensor test (Figure 38) can help you determine whether they may be a problem with the HQ Sweet Sixteen motor. Slowly rotating the hand wheel should result in an audible "beep." If you get a constant solid "beep" or no "beep" at all, this indicates a failed test and the machine should be inspected by a qualified Handi Quilter repair technician.

Press the "Main" button to return to the "Main" menu screen or the "Back" button to return to the "More" menu screen.

Needle Sensor Test

The Needle Sensor test will indicate whether the needle position sensor is functioning properly. Rotating the hand wheel should result in a "beep" for half of a stitch cycle followed by no "beep" for the other half. (Figure 39)

If you hear a constant beep or no beep at all for a full 360° rotation of the hand wheel, this indicates a failed test and the machine should be inspected by a qualified Handi Quilter repair technician.

Press the "Main" button to return to the "Main" menu screen or the "Back" button to return to the "More" menu screen.

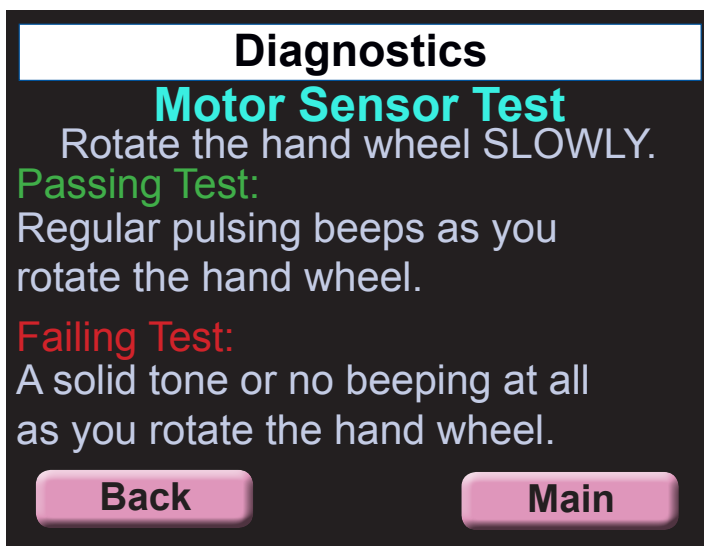

Figure 38

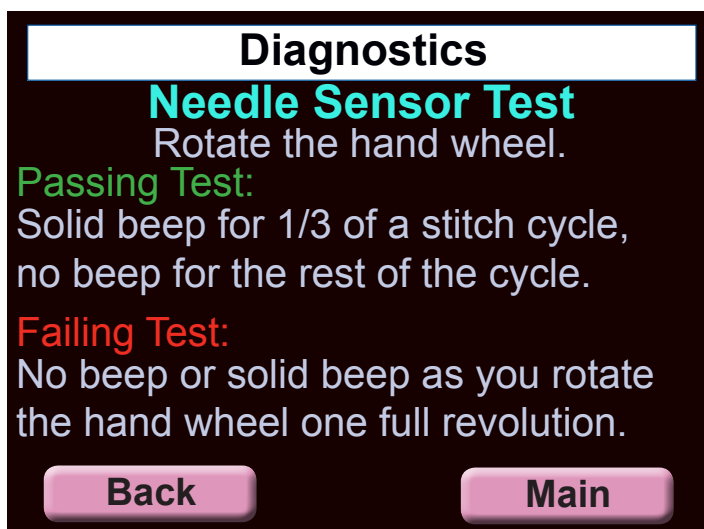

Figure 39

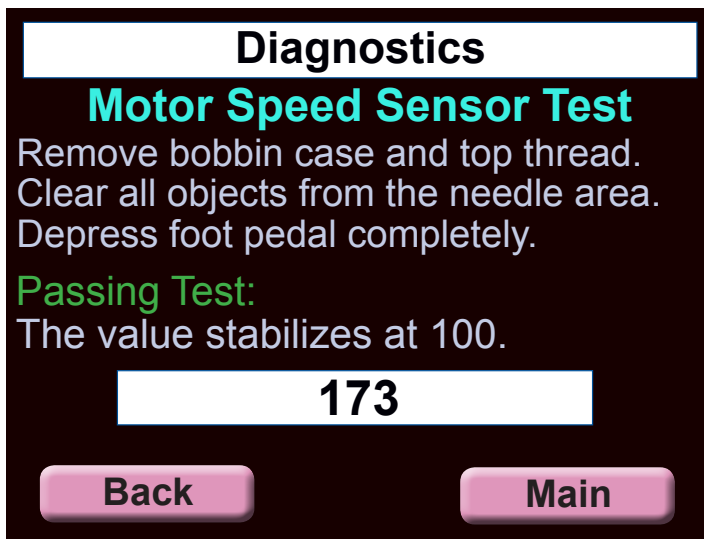

Figure 40

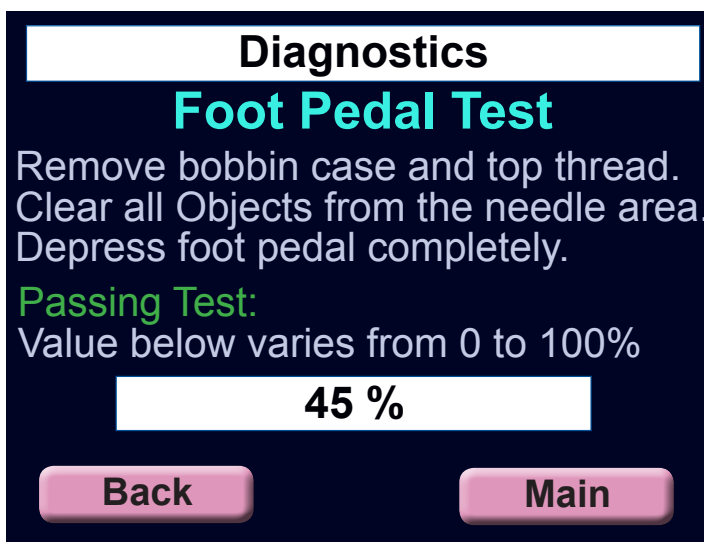

Figure 41

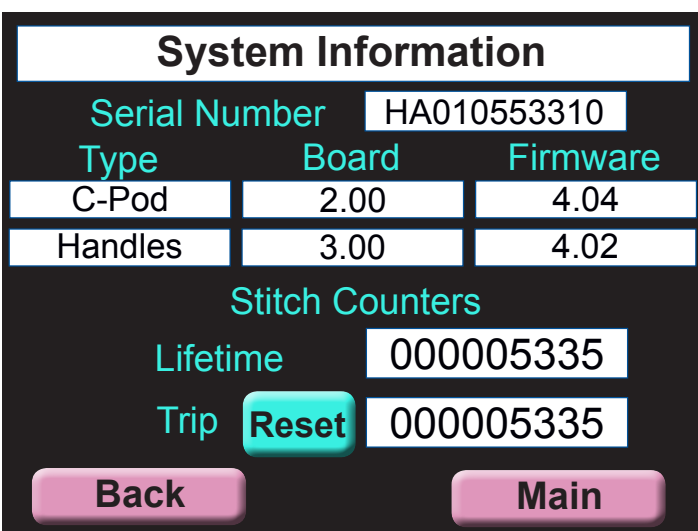

Figure 42

Motor Speed Sensor Test

The “Speed” Sensor test can help you determine whether or not there is a problem with the HQ Sweet Sixteen speed sensor. Before performing this test, remove the bobbin case and the top thread. Press the foot pedal so that the machine will begin slowly rotating. The white box will show a number that should stabilize at 100 if the sensor is functioning properly. Release the foot pedal to stop the machine. (Figure 40)

Press the “Main” button to return to the “Main” menu screen or the “Back” button to return to the “More” menu screen.

Pedal Test

The “Pedal” test can help you determine if there is a problem with the HQ Sweet Sixteen foot pedal. As you slowly depress the foot pedal a percent of depression will appear in the white box. The foot pedal should be controllable from 0 to 100%. (Figure 41)

Press the “Main” button to return to the “Main” menu screen or the “Back” button to return to the “More” menu screen.

System Information Screen

The serial number of the machine is displayed at the top of the System Information screen. This number matches the one found on the label at the back of the machine.

Information contained in the white boxes below the serial number identifies the electronics board revision numbers as well as the firmware revision numbers of the HQ Sweet Sixteen.

The Lifetime and Trip (or project) stitch counters count the number of stitches the machine is performed. The Lifetime count is the total number of stitches made since the machine was built. The Trip Counter can be reset to keep track of the number of stitches made during a given project. To reset this counter, press the blue “Reset” button found aligned with the Trip counter.

The Lifetime counter cannot be reset and should be used as an indicator to determine when general machine maintenance should be performed by an authorized Handi Quilter Representative. (Figure 42)

Press the “Main” button to return to the “Main” menu screen or the “Back” button to return to the “More” menu screen.

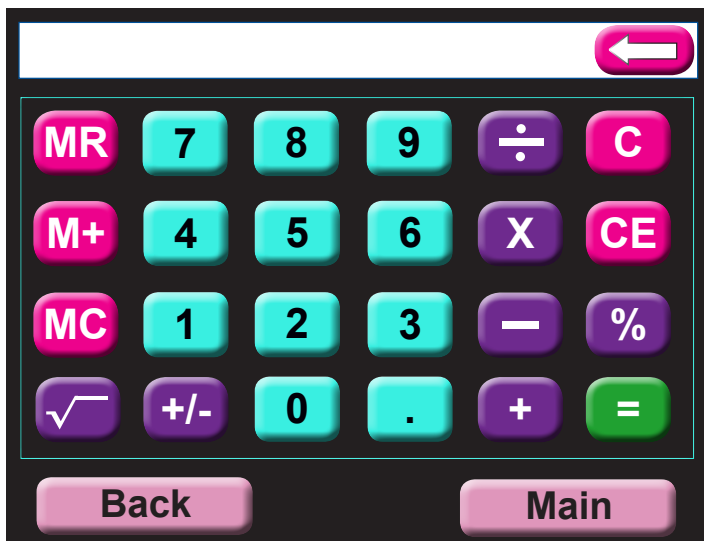

Figure 43

Calculator Screen

A basic six-function calculator is provided for your convenience. (Figure 43) The functions provided are addition, subtraction, multiplication, division, square root and percent. The arrow button on the top right may be used to delete a digit mistakenly entered.

Press the “Main” button to return to the “Main” menu screen or the “Back” button to return to the “More” menu screen.

Calibrate Tension

The Tension button on the Diagnostics menu enables you to calibrate the tension device. You should only calibrate the tension device under the direction of Handi Quilter technical support. (Figure 44)

While calibrating the tension, you will be asked to do the following:

1. Remove the tension knob.
2. Gently press the spring against the tension discs while not compressing the spring.
3. While holding the spring in place, press Reset.
4. When calibration is complete, replace the tension knob.

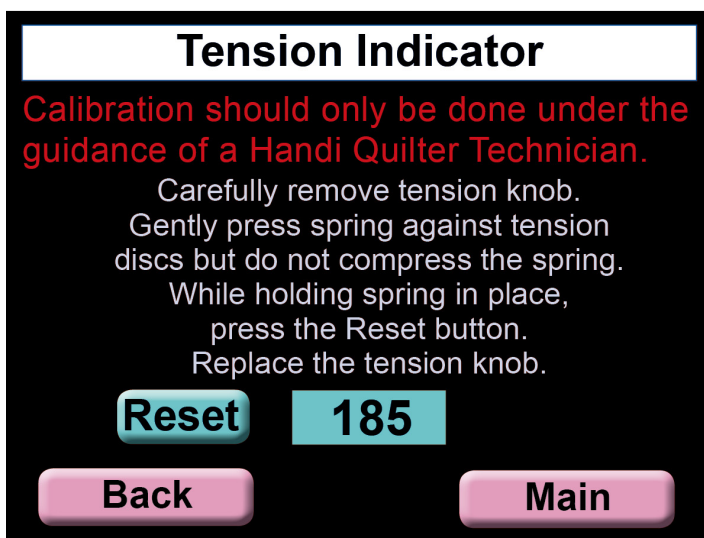

Figure 44

Getting Started Quilting

Thread Requirements

Threads have a tendency to dry rot over a period of time. Be sure to choose high quality threads for your valuable heirloom quilts. Most machine quilting threads on the market today are acceptable.

Needle Requirements

For general quilting, a size 16/100 needle will accommodate most threads and fabrics. Heavier threads, such as top stitch and some decorative threads, require a larger needle such as 18/110 or 20/120. Heavier fabrics such as denim, canvas or densely woven fabric may require a larger needle.

To Prepare for Quilting

With any quilting machine, it is important to understand the basics of free motion quilting. The HQ Sweet Sixteen Quilting Machine does not have feed dogs like domestic machines; therefore, the fabric does not automatically feed under the hopping foot. The operator controls the machine sewing speed with the My Speed setting and the foot pedal, and moves the fabric to get an even, consistent stitch.

In order to become comfortable using the HQ Sweet Sixteen, quilters can begin with a few simple techniques using a sample quilt sandwich (two pieces of fabric with a layer of batting between them).

Set the machine at a medium My Speed setting (perhaps 25%) and begin moving the fabric until you become accustomed to the resistance. By moving the fabric faster, the stitches begin to elongate. The My Speed setting can either be increased or the fabric can be moved slower to get the stitches back to the desired length. By moving the fabric slower, the stitches get shorter and can build up on top of each other, breaking the thread or making it extremely difficult to unpick.

The My Speed setting can be decreased or the foot pedal released slightly, while maintaining a constant motion with the fabric, to bring the stitches back to the desired length.

When quilting, relax your hands and maintain a light touch on the fabric. Gripping the fabric too tightly may cause body tension resulting in poor quilting quality and discomfort.

Different colors of fabric may require different brightness settings for the LED light ring to prevent eye strain.

Correcting Common Issues

Skipped Stitches	Corrective Measure
<ul style="list-style-type: none"> The needle is damaged, dull, bent, or installed improperly Incorrect needle size Very tightly-woven fabric (such as batiks) Needle has not been positioned properly Thread tension too tight Improper threading 	<ul style="list-style-type: none"> Replace the needle often, normally once or twice per day for continuous quilting or at least once per quilt. Use HQ Sweet Sixteen recommended needles. Always change the needle if the needle has struck any hard object such as a straight pin, etc. The tip of the needle can become damaged or burred, resulting in fabric damage as well as skipped stitches, thread breakage or shredding. Always change the needle if it has been hit, bumped or pulled off center while maneuvering the machine about the quilt. A slightly bent needle can be a major cause of skipped stitches. Check for the proper combination of needle size and thread weight being applied to the quilting operation. Some fabrics used in quilting may constrict or impede the thread passing through the front groove of the needle. This diminishes the loop lift required for stitch formation. Typically, a larger needle will solve the problem; however, it has been found that certain smaller sizes of needles as well as the use of ball-pointed needles solve some specific problems. Position the needle properly to the needle bar. Inspect the position of the needle to make sure the needle is at the 6 o'clock position (see Photo 16)—If you stand directly in front of the needle (facing the bobbin case side of the machine), you will see the entire needle eye directly facing you. This is 6 o'clock position. Make sure (1) the needle is installed all the way into the needle bar to the needle stop hole in the needle bar, (2) the long groove in the needle is toward the front (bobbin case side), and (3) the scarf/scooped out part of the needle is toward the handwheel. The needle can sometimes be rotated to 5 o'clock (slightly right) or 7 o'clock (slightly left) in order to adjust for a more positive thread loop pickup by the hook point. Loosen top tension. Re-check top and bobbin tension (see pages 18-20). Inspect that the thread take-up lever, thread stirrup or tension spring are all threaded correctly.
The Needle Breaks	Corrective Measure
<ul style="list-style-type: none"> The needle is bent or not installed properly The needle hits the needle plate 	<ul style="list-style-type: none"> Replace or correctly change the needle. Make sure that the needle is pushed up into the needle bar clamp until it can go no farther (visually check that it is up to the top of the stop/sight hole above the needle bar clamp screw). Failure to do so can cause damage in the bobbin area and throat plate. Correctly position the needle, needle plate or hopping foot. Replace needle with a new one.
Stitches Are Puckered	Corrective Measure
<ul style="list-style-type: none"> Tension is not balanced Needle too large for material 	<ul style="list-style-type: none"> Balance the tension of the needle thread after ensuring the bobbin tension is adjusted correctly (see page 20). Replace the needle with a size better suited to the fabric.

Correcting Common Issues

Stitch Quality Is Poor	Corrective Measure
<ul style="list-style-type: none"> Tension is not balanced Bobbin case is damaged, corroded, dirty, et cetera Moving the fabric or depressing the foot pedal inconsistently 	<ul style="list-style-type: none"> Adjust the tension of the needle thread after ensuring the bobbin tension is adjusted correctly (see page 19). Since thread slides over the surface of the bobbin case at a high speed, make sure the case is free of any lint or foreign matter that could impede thread passage through the machine. The My Speed setting should be adjusted to a value that will allow you to sew comfortably and confidently with the foot pedal fully depressed. Discover a method of holding the fabric that is most comfortable.
Tension Is Poor	Corrective Measure
<ul style="list-style-type: none"> Lint caught under the tension spring in the bobbin case Poorly wound bobbin 	<ul style="list-style-type: none"> With some threads, lint and other material can build up under the tension leaf spring and begin to lift the spring. This reduces the spring's ability to compress against the thread. By inserting a needle under the spring and clearing out the lint, the bobbin tension will return to the previously set tension. If the bobbin is wound too tight or too loose it can lead to poor and inconsistent tension. Make sure when the bobbin is wound that the thread tension is not so tight that the wound bobbin thread feels hard and causes the bobbin sides to bulge. It should also not be so loose that the thread is spongy, which can cause the thread to tangle as it is wound.
Hand Wheel Won't Rotate	Corrective Measure
<ul style="list-style-type: none"> Thread is entangled and caught in the hook 	<ul style="list-style-type: none"> Turn off the machine and remove the power plug from the electrical outlet. Remove the bobbin case from the machine. Lubricate the hook, then manually rotate the hand wheel clockwise and counter-clockwise several times. Remove the thread caught in the hook.
Thread Nests Under Quilt	Corrective Measure
<ul style="list-style-type: none"> Not enough tension on top thread Improper threading 	<ul style="list-style-type: none"> Check that the machine is threaded correctly. Make certain that the thread is flossed snugly in place between the two tension discs. If the machine is correctly threaded, tighten the top tension by rotating the tension knob clockwise. Refer to the threading diagram and threading instructions on page 16.
Motor Fails to Run	Corrective Measure
<ul style="list-style-type: none"> On/Off switch is off or power cord is loose Foot pedal is unplugged 	<ul style="list-style-type: none"> Turn the machine on only by using the switch on the back of the power pod. Verify the power cord is plugged in tightly at both the machine and the power source. Verify that the foot pedal is plugged in. If the main screen status message in the upper left hand corner says "Check Pedal", then the pedal is not properly installed.

Correcting Common Issues

Needle Thread Breaks	Corrective Measure
<ul style="list-style-type: none"> • Top and bobbin tension not balanced • Thread cones/spools are poor quality or may have severe twisting or thread rot • The machine head has been threaded incorrectly or thread spools are not positioned correctly • Particles in tension discs • Bobbin rotation is not smooth • Needle is burred, bent or dull, or installed incorrectly • Needle not suited for the thread • Hesitating too long at one point in the pattern • Improper needle/hook relationship • Damage or burr at the needle hole in the needle plate or any other place along the thread path • Wrong type of needle • Other possible causes: 	<ul style="list-style-type: none"> • Check the tension of the top tensioner and bobbin for proper balance. • Look for severe twisting of threads when approximately 12 to 15 inches has been pulled off, with ends pinched together. Cotton threads are particularly susceptible to dry rot which makes thread brittle. Do not use poor quality thread, or thread that is rotted or brittle. • Check that the machine is threaded correctly. • Inspect for accidental double wrapping of thread on thread guides. • Inspect the thread mast making sure the eyelets of the mast are directly over the spools. • Inspect the vertical positioning of the thread cones. Tipped cones can dramatically affect thread tension and can cause breakage. • Inspect for particles and remove any lint or debris. • Change the bobbin. The slightest hesitation of the bobbin rotation can be the cause of dramatic tension change and thread breakage. Use ONLY HQ bobbins • Change the needle at least once per quilt. Make sure the needle is installed to the top of the sight hole in the needle bar. • Replace the needle with one better suited for the thread. Use the proper size needle. • Move more quickly so stitches don't overlap or build up. When starting the machine, begin moving immediately. Sewing in one place too long will cause the thread to break. • Timing of the machine is improper. Consult a repair technician at your local, authorized Handi Quilter representative. • If the thread is shredding at the needle plate, check for burrs or jagged edges. Gently rub with metal cloth to remove the sharp edge. Consult a repair technician to polish any hard to reach or delicate areas, or if the burr is inside the hole. • Use needles recommended by Handi Quilter. Using the wrong needle with a smaller shank diameter causes many problems. For example a system 1738 or 287WH needle with a shank diameter of 1.64mm will fit loosely into the clamp at an angle. This may cause skipped stitches because the needle is positioned too far away from the hook point. It can also cause the needle to hit the hook, breaking the needle. • The needle is too close to the hook, which causes friction and a possible collision of the hook point and the needle. • Needle plate damage. • Hook damage. • Broken needle inside needle bar clamp, preventing the needle from insertion to the top of the clamp. • Damaged needle bar clamp.
No Visible Display	Corrective Measure
<ul style="list-style-type: none"> • Cable unplugged 	<ul style="list-style-type: none"> • Check the communication cable that connects the display to the machine and make sure the connection is secure.

Accessories

(available from your local HQ Retailer or at www.HandiQuilter.com)

Horizontal Spool Pin

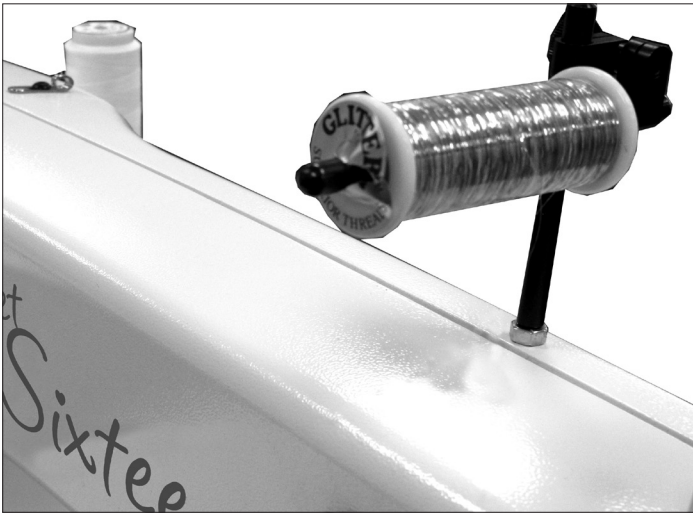

Figure 45

An optional horizontal spool pin is available for use with delicate threads such as metallics or holographic threads or for specialty threads that are wound on a spool (not a cone). Some threads twist and break if fed from a vertical spool.

HQ Sweet Sixteen 18" Table Extension

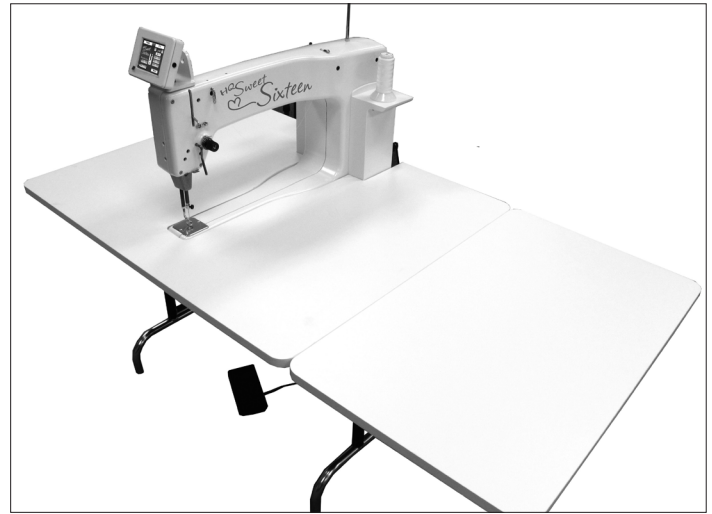

Figure 46

Expand your original HQ Sweet Sixteen table with HQ Sweet Sixteen Table Extensions. Each extension measures 18" x 30". Purchase one or two to provide extra support for large projects.

Adding two extensions will expand the original table to a full six feet in width (one extension shown above).

Handi Feet Couching Kit



Figure 47

The Handi Feet Couching Kit includes three sizes of interchangeable couching feet: 1.5mm, 2mm, and 3mm. You'll have just the right size foot for adding couching embellishments using a variety of specialty threads, fibers, and yarns to your quilt.

Debbie Brown DVD's



Figure 48

Sit-Down Longarm Quilting Featuring Debby Brown, Handi Quilter National Educator
Video 1: Getting Started
Video 2: Quilting Blocks and Borders
Video 3: Using Rulers and templates
Video 4: Thread Work



501 North 400 West
North Salt Lake, UT 84054
801-292-7988 • 877-697-8458
Email: sales@handiquilter.com
www.HandiQuilter.com

Warranty issues should, whenever possible, first be submitted to the Authorized Retailer who completed your service and training. These Retailers have been selected for their dedication to customer satisfaction and have been trained in technical service. They also may provide follow-up advice, training, service, accessories, and other services.

HQ Authorized Retailers may offer their own warranties in addition to those offered by the manufacturer, but do not obligate the manufacturer.

HQ Quilting Machine Limited Warranty

Handi Quilter, Inc. (*hereinafter HQ*) offers a limited warranty on the HQ Quilting Machine (*hereinafter "Machine"*) to be free of defects in workmanship and materials under normal use upon the terms and conditions hereinafter set forth:

- (a) **90 day Limited Warranty:** During the first 90 days from date of purchase, HQ will repair any manufacturing defect without charge for parts or labor. All subsequent warranties include parts costs only.
- (b) **5-year Mechanical Warranty:** For any mechanical failure within this period. Manufacturer will provide free replacement parts, customer pays for labor and shipping.
- (c) **5-year Electronic/Electrical Warranty:** The electric/electronic components are warranted to be free from manufacturing defects for five years from the date of purchase. If any defect is reported within this period, manufacturer will provide free replacement parts, customer pays for labor and shipping. The 5-year electronic/electrical warranty will be invalid if the machine is left plugged into a power source when not in use.
- (d) **10-year Limited Manufacturer's Warranty:** HQ warrants the sewing head is free of casting or machining imperfections causing product failure. This warranty does not extend to mechanical or electronic/electrical parts, which are covered under a separate warranty, or consequential damage to the head caused by mechanical or electronic/electrical part failures beyond their warranty period.

The limited warranty stated in sections (b), (c) and (d) above shall be limited solely to the replacement of parts which, in the opinion of HQ, are defective in workmanship or material and are returned to HQ, or an authorized repair facility, or such other point or place that may be designated by HQ. All other costs, including cost of freight and shipment for repair under this warranty, shall be the customer's costs.

The machine registration card must be completed and received by HQ before warranty is valid.

Warranty Exclusions: HQ shall have no obligation for any claim under this warranty if the machine has been misused, abused, neglected, damaged in transit or has been altered from the standard specifications established by HQ, or if proper maintenance and lubrication have not been timely performed.

No warranties extend beyond the express warranty offered. HQ disclaims all other warranties, express or implied, regarding the Products, including any implied warranties of merchantability or fitness for a particular purpose. In the United States, some laws do not allow the exclusion of the implied warranties.

Specific exclusions of warranty limitations include, but are not limited to, the following:

- General, consequential, incidental or special damages including damage to fabric or material, the cost of rework or lost profits, the cost of installation or removal of any Products, and any inspection, testing, or redesign caused by any defect or by the repair or replacement of Products arising from a defect in any Product.
- Products which are received by HQ improperly packaged, altered, or physically damaged.
- Counterfeit or altered label(s) or stickers.
- Broken pins on connectors.
- Stripped screws or nuts.
- Connector(s) damaged, cracked, missing or broken.

- Missing, torn or punctured seal(s).
- Any use besides machine quilting applications using customary fabrics, threads and accessories.
- Operator error in the customary use of the Product.
- Internal adjustments, tampering or parts replacement done by anyone except authorized Retailers or customers specifically authorized by Handi Quilter Customer Support or warranty repair personnel on a case by case basis.

The warranty does not cover and the user assumes the risk of and there is hereby excluded any liability to HQ for failure, defects, loss, deterioration, personal injury or damage which are due to: (1) ordinary wear and tear or exposure, (2) abuse, misuse, negligence, or (3) use of parts not authorized by HQ.

In no event shall HQ be liable to the purchaser of the Machine or to third parties for special or consequential damages, including, but not limited to, death or personal injuries.

HQ does not assume, or authorize any person to assume on its behalf, any other obligation of liability other than that set forth herein.

Some states do not allow exclusion of limitation of incidental or consequential damages, so above limitation or exclusion may not apply. This warranty gives the purchaser specific legal rights and the purchaser may also have other rights, which may vary for State to State.

Exclusive Remedy: Remedy is limited to the repair or replacement of the defective Product. HQ may elect which remedy or combination of remedies to provide at its sole discretion and shall have a reasonable time, after determining that a defective Product exists, to repair or replace the defective product. Replacement Product may be from new or serviceable used parts. HQ's warranty applies to repaired or replaced Products for the balance of the applicable period of the original warranty or ninety days from the date of shipment of a repaired or replaced Product, whichever is longer.

HQ's entire liability for any defective Product shall in no event exceed the purchase price for the defective Product. This limitation applies even if Handi Quilter cannot or does not repair or replace any defective Product.

Service under the above warranties may be obtained by returning the quilting machine, with proof of purchase, to the authorized Retailer from whom the machine was purchased, a local Retailer, or to Handi Quilter Customer Support.

Any product to be returned to the factory, either by customers or Retailers, must be accompanied by a Return Material Authorization Number (RMA). RMAs may be obtained by email (sales@handiquilter.com) or by calling customer support toll free at 1-877-697-8458. If it is determined that the Product may be defective, an RMA number will be issued with instructions for Product return. An unauthorized return (a return without an RMA number) will be shipped back to customer at customer's expense. Authorized returns are to be shipped prepaid and insured in an approved shipping container. The original box and packaging materials should be kept for storing or shipping.

Shipping Costs: Shipping is the responsibility of the customer.

Product Service and Maintenance: Replace needles every 2 to 4 hours (1 to 2 per large quilt) and lubricate bobbin hook every 3 to 4 hours of use. Periodically check the thread tensioner. Use a small brush to clean out all lint, loose thread or obstructions from the bobbin hook.

Servicing is recommended annually from a qualified Retailer. Servicing will cover belt tensioning, encoder positioning, bearing retainers, hook axial play and timing, presser and needle-bar adjustment and internal lubrication to take-up lever, hopping foot levers, bushings/bearings

Handi Quilter, Inc.
 Customer Relations
 501 North 400 West
 North Salt Lake, Utah 84054

Handi Quilter Warranty Registration

Mail or Fax completed Warranty Registration Card **within 30 days of purchase**. If you have questions, email HQCares@HandiQuilter.com or call Customer Relations at 1-877-697-8458. Online warranty registration is also available at HandiQuilter.com.

MAIL TO: Handi Quilter, Inc.
Warranty Registration Dept.
501 N 400 W
North Salt Lake, Utah 84054

FAX TO: 801-294-3011

The HQ Quilting Machine warranty is 10 years manufacturer's warranty on casting and machining of the case, 5 years electronic/electrical, and 5 years mechanical. Check with your local HQ Retailer for details on service or making warranty claims.

HQ Quilting Machine Model (check one): HQ Sweet Sixteen® HQ Simply Sixteen® HQ Avanté®
 HQ Amara™ HQ Forte™ HQ Fusion® HQ Infinity®

Customer Name: _____

Company/Business Name (if applicable): _____

Address: _____

City, State, Zip: _____

Daytime Phone: _____ Evening Phone: _____

Fax: _____ Email: _____

HQ Serial Number: _____ Order Number (5 digits): _____

Purchase Date: _____ Date Machine Received: _____

Location of Purchase (Shop or Show name, City & State): _____

Type of use intended: Home/Personal Some commercial Share w/Friends Mostly commercial
 Other _____

Type of machine-quilting skills: Novice Intermediate Experienced

Skill adjusting sewing machines: Novice Intermediate Experienced

Signature: _____ Date: _____

Cut along dotted line and mail or fax this registration information within 30 days of purchase.

This page was intentionally left blank.

HQ Quilting Machine New Owner and Training Checklist and Certificate



You are entitled to a one-time free introductory training class on the use of your HQ quilting machine as well as free adjustments for 60 days and any repairs covered by the warranty. Present this checklist to your authorized HQ quilting machine Retailer to receive these free services.

Table

- How to adjust length
(Not applicable for HQ Sweet Sixteen)
- How to adjust height

Machine Setup

- Identify the main parts of the machine
- Ensure machine is properly mounted to the carriage or table
- Check all cable connections
- Ensure power outlet is available and does not cause a trip hazard
- Recommend and explain the importance of a power strip with surge protection
- Ensure the table is level
- Show how to wind a bobbin (*including how to adjust the tensioner and the capacity lever*)
- Show how to load a quilt

Machine Operation (all machines)

- How to turn the machine on and off (both switches)
- How to change the needle
- How to change the Handi Feet
- How to properly thread the machine
- How to set the bottom tension (*bobbin case*); teach the drop test
- How to set the upper tension with Easy-Touch Tension
- How to bring up the bobbin thread
- How to tie off
- How to use the menus: explain each menu
- How to adjust lighting

Machine Operation

(HQ Avanté, HQ Fusion, HQ Infinity)

- How to switch between stitch regulation and manual mode
- How to set the speed in manual mode
- How to set the stitches-per-inch in stitch regulation
- How to use Cruise stitch regulation
- How to use Precision stitch regulation
- How to use the front and rear handlebars
- How to use the laser pointer stylus and the included pantograph
- Review features unique to the purchased machine

HQ Sweet Sixteen only

- How to use the foot control
- How to use the color touch screen
- How to use the functions of the touch screen
- How to set the presets and My Speed
- How to use needle up/down and tie-off buttons

Machine Maintenance

- How to oil the bobbin hook: where, how, and when
- How to clean the bobbin hook area
- How to clean wheels and tracks (*where applicable*)

IMPORTANT: Read before signing

By signing this training checklist you are acknowledging you have been personally instructed in the operation of the Handi Quilter machine you purchased. Additional training by this HQ Retailer or any other HQ Retailer may result in being charged for additional instruction.

Customer Name _____

Customer Signature _____

Training Date _____

Trainer Name _____

Retailer Signature _____

HQ Retailer Business Name _____

Business City and State/Province _____

HQ Quilting Machine Model (circle one)

HQ Avanté /Amara HQ Fusion/Forte HQ Infinity
HQ Sweet Sixteen

Machine Serial Number _____

Representative: To register training services provided, return completed and signed certificate by FAX (1-801-294-3011) or MAIL:

Handi Quilter
501 North 400 West
North Salt Lake, UT 84054

Retain a copy for your records.



Handi Quilter

BY QUILTERS FOR QUILTERS

Handi Quilter, Inc.
501 N 400 W
North Salt Lake, UT 84054

1-877-MY-QUILT (697-8458)
www.HandiQuilter.com

The family of innovative quilting products from Handi Quilter

