

HQ *Capri* 18™

USER MANUAL

VERSION 1.1



HQ *Capri* 18™

USER MANUAL

VERSION 1.1



© 2019 Handi Quilter, Inc. All rights reserved.

The information contained in this document is subject to change without notice. If you find any problems in the manual, please report them to us in writing. This document is not warranted to be error-free. Handi Quilter, Inc. assumes no responsibility or liability for any errors or inaccuracies that may appear in the informational content contained in this manual.





Handi Quilter®, HQ Capri™, HQ InSight Table™, HQ InSight Stitch Regulation™, Handi Feet™, and Easy-Set Tension™ are all trademarks or registered trademarks of Handi Quilter, Inc. Digital tensioner U.S. Patent No. 8,997,669. InSight Stitch Regulation U.S. Patent Nos. 9,840,797, 10,100,449, and 10,240,270

Printed in the United States of America.

Version 1.1 06/2020

How to Use This Manual

Special Information

-  **NOTE:** A NOTE indicates important information that helps you make better use of your Handi Quilter product.
-  **IMPORTANT:** An IMPORTANT note provides information that is essential to properly using your Handi Quilter product.
-  **CAUTION:** A CAUTION indicates a potential for causing harm to your quilting machine, the quilt, or to yourself.
-  **ONLINE:** Indicates there is more information online, such as a video.
-  **QUILTING TIP:** Handi Quilter educators share tips to get you started quilting.

Finding Information

What are you looking for?	Find it here
Warranty Information.....	<i>User manual</i>
Safety Information.....	<i>User manual</i>
Regulatory Information	<i>User manual</i>
What's Included with your Machine	<i>User manual</i>
Machine Specifications.....	<i>User manual</i>
HQ InSight Table Setup Information	<i>HQ InSight Table Assembly Instructions</i>
Machine Setup Information	<i>User manual</i>
How to Thread your Machine.....	<i>Quick reference card</i>
Needle System for your Machine	<i>Quick reference card</i>
Getting Started with Quilting	<i>Getting Started videos - USB stick</i>
Online Videos	www.youtube.com/user/HandiQuilterHQ
Basic Maintenance	<i>User manual</i>
Troubleshooting	<i>User manual</i>
Tips and Tricks	www.HandiQuilter.com/Live/ https://www.youtube.com/user/HandiQuilterHQ/videos
Training and Education Options.....	www.HandiQuilter.com
Customer Care/Technical Support.....	<i>1-877-MY-QUILT (697-8458) or 801-292-7988</i> <i>Available 8:00 AM to 5:00 PM Mountain Time, Monday to Friday</i> HQcares@HandiQuilter.com
Community.....	<i>Forum: https://support.HandiQuilter.me/hc/en-us/community/topics</i> <i>Blog: https://HandiQuilter.com/blog/</i> <i>Facebook: www.facebook.com/HandiQuilter</i>

Table of Contents

- Congratulations on Your Purchase!4**
- What’s Included with Your Machine4**
- Important Safety and Machine Information4**
 - Important Safety Instructions5
 - To Use the Machine Safely8
 - To Increase the Life of Your Machine8
 - To Repair or Adjust the Machine8
 - About your Machine.9
- General Specifications.9**
 - HQ Capri Components10
- Installation and Setup13**
 - Setting up the Table13
 - Placing the Machine in the Table13
 - Installing the Foot Pedal14
 - Installing the Thread Mast14
 - Installing the Color Touch-Screen15
- Using Your Machine.16**
 - Needle/Thread Selection Guide16
 - Changing the Hopping Foot16
 - Threading the Machine17
 - Inserting (or Changing) the Needle19
- Bobbin Case and Bobbin Thread Tension Adjustments20**
 - Inserting the Bobbin.20
 - Drawing the Bobbin Thread to the Top of the Quilt21
 - Checking and Adjusting Bobbin Case Tension21
 - Tighten Bobbin Case Tension.21
- Easy-Set Tension™ Adjustment.22**
 - Tighten Top Thread Tension.22
 - Loosen Top Thread Tension22
- Maintenance23**
 - Cleaning and Lubricating the Machine23
 - Cleaning the Touch-Screen Display23
- Using The Touch-Screen Display24**
 - Main Screen Manual Mode Button Functions24
 - (A) Pause/Play Indicator24
 - (B) My Speed24
 - (C) Limit Controls24

(D) Presets	25
(E) Basting Mode In Manual Operation	25
(F) Easy-Set Tension	25
(G) Bobbin Thread Indicator	26
(H) Needle Stop	26
(I) Up/Down/TieOff	27
Main Screen Regulated Mode Button Functions	27
Stitches Per Inch (SPI).	27
Basting Stitches	27
Precision	28
Cruise.	28
Tools Menu	29
Low Bobbin	30
Timer And Stitch Count	31
Alarms	31
Lighting	32
Calculator Screen	32
Diagnostics Screen	32
Diagnostics Tests	33
Motor Sensor Test	33
Speed Sensor Test.	33
Motion Sensors.	34
Needle Sensor Test	34
Tension Calibration.	35
Foot Pedal Test	35
Language	36
Update	37
System Information Screen.	38
Getting Started Quilting	39
Thread Requirements	39
Needle Requirements	39
To Prepare for Quilting	39
Troubleshooting.	39
Accessories	44
Appendix 1.	45
Handi Quilter Machine Warranty.	46
Training Checklist and Certificate.	50

Congratulations on Your Purchase!

You haven't just purchased a quilting machine, you've joined the Handi Quilter family and we welcome you. You have acquired the most advanced quilting machine available in today's market.

Handi Quilter is committed to innovation, reliability, customer service, and education. Our machines are *Designed by a Quilter, for Quilters*® and we are committed to your quilting success. With that in mind, we invite you to bookmark our website: www.HandiQuilter.com and invite you to visit to learn more about the art of quilting. We've posted videos on subjects as diverse as *Oiling Your Machine* to *Making Perfect Feathers*. Your new quilting friends are already there, waiting for you! Remember, if you ever have questions, your local HQ authorized retailer can help you. If the retailer is not available, contact Handi Quilter directly at HQcares@HandiQuilter.com or by calling us, Monday through Friday, 8:00 AM to 5:00 PM Mountain Time (1-877-697-8458 or 1-801-292-7988).

Keep the carton and packing materials. You will need them if you need to return the machine to the retailer or send it for repair. If you don't pack the machine properly or if you don't use the correct packaging materials, the machine could be damaged. Handi Quilter is not liable for damage that occurs during return shipping.

- **IMPORTANT:** These packaging materials are designed to prevent the machine from being damaged. Keep them in case you need to bring this machine to the dealer or send it for repair.

What's Included With Your Machine

- Bobbins (5)
- Bobbin case
- Needle (134) size 100/16 (pack of 10)
- Needle (134) size 110/18 (pack of 10)
- Thread tray and thread mast
- EZ Pen Oiler
- Power cord
- Screwdriver
- 2.5 mm hex wrench
- 3 mm hex wrench
- 4 mm hex wrench
- Open-toe Handi Foot (ruler foot installed)
- Quick Reference Card
- HQ Bobbin Winder
- HQ Capri Quilting Machine

Important Safety and Machine Information

This device complies with Part 15 of the FCC Rules. Operation is subject to the following two conditions: (1) This device may not cause harmful interference, and (2) this device must accept any interference received, including interference that may cause undesired operation. See the full Declaration of Conformity in the Appendix.

- **IMPORTANT:** Do not operate your HQ Capri quilting machine until you have completely read the information contained in this manual. Please keep all packaging and order information for warranty purposes.

IMPORTANT SAFETY INSTRUCTIONS

Read all instructions before using this machine.

When using this machine, basic safety precautions should always be followed, including the following:

DANGER — To reduce the risk of electric shock:

- A quilting machine should never be left unattended when plugged in. Always unplug the machine from the electrical outlet immediately after using and before cleaning.

DANGER — Pour réduire le risque de choc électrique :

- Une machine à quilter ne doit jamais être laissée sans surveillance lorsqu'elle est branchée. Débranchez toujours la machine de la prise électrique immédiatement après usage et avant de la nettoyer.

WARNING — To reduce the risk of burns, fire, electric shock, or injury to persons:

- The HQ Capri is heavy. Never attempt to lift it alone. Always use two people when lifting. Always lift from the throat of the machine.
- Always unplug the HQ Capri from the electrical outlet when performing any maintenance, changing the needle, removing thread locks, or when left unattended.
- Do not unplug by pulling on cord. To unplug, grasp the plug, not the cord.
- Keep fingers away from all moving parts. Use caution around the needle or sharp external components.
- Change the needle often. Do not use bent or dull needles. “Every quilt deserves a new needle”.
- Switch the machine to the symbol off, or 0, position to turn it off when making any adjustments in the needle area, such as threading needle, changing needle, threading bobbin, changing hopping foot, and so forth.
- Never drop or insert foreign objects into any opening.
- The HQ Capri should only be used indoors away from moisture.
- The HQ Capri should not be stored or used in extreme temperatures.
- Use the HQ Capri only for its intended use as described in this manual.
- To disconnect from the wall outlet, push the switch to the off position, then remove the plug from outlet pulling from the plug, not the cord. Never operate the HQ Capri if the cord is damaged or not working correctly. If a mechanical or electrical problem is encountered, return the HQ Capri to the nearest authorized service center or the manufacturer for examination, repair, electrical, or mechanical adjustment.
- It is not recommended that the HQ Capri quilting machine be used with any machine quilting frame other than those recommended by Handi Quilter.
- Use this quilting machine only for its intended use as described in this manual. Use only attachments recommended by the manufacturer as contained in this manual.
- Never operate the machine with any air openings blocked. Keep ventilation openings of the machine free from the accumulation of lint, dust, and loose cloth.
- Do not operate where aerosol (spray) products are being used or where oxygen is being administered.

- Do not pull or push the machine across the fabric excessively while stitching. It may deflect the needle enough to cause it to break.
- Use only needles designed for free motion quilting and recommended by Handi Quilter for this machine. Other types of needles may be break during normal quilting.
- Children shall not play with the machine. Close attention is necessary when this machine is used by or near children.
- This sewing machine may be used by children age 8 years and above and persons with reduced physical, sensory, or mental capabilities or lack of experience and knowledge if they have been given supervision or instruction concerning use of the machine in a safe way and understand the hazards involved.
- Cleaning and user maintenance shall not be made by children without supervision.

AVERTISSEMENT — pour réduire le risque de brûlures, d'incendie, de choc électrique ou de blessures

- La HQ Capri est lourde. Ne tentez jamais de la soulever seule. Utilisez toujours deux personnes pour la soulever. Soulevez toujours la machine à partir de la gorge, non pas à partir des poignées.
- Débranchez toujours la HQ Capri de la prise électrique lors des travaux d'entretien, du changement d'aiguille, de la suppression des blocages de fil, ou lorsqu'elle est laissée sans surveillance.
- Ne pas débrancher en tirant sur le cordon. Pour débrancher, saisir la fiche, non le cordon.
- N'approchez pas les doigts des parties mobiles. Faites preuve de prudence lorsque vous vous approchez de l'aiguille ou de composants externes tranchants.
- Changez souvent d'aiguille. N'utilisez pas d'aiguilles tordues ou émoussées. « Chaque quilt mérite une nouvelle aiguille ».
- Mettez la machine sur la position 0 ou de symbole d'arrêt pour l'éteindre lorsque vous effectuez des réglages dans la zone de l'aiguille : enfilage de l'aiguille, changement d'aiguille, bobinage de la canette, changement de pied, etc.
- Ne faites jamais tomber et n'insérez jamais d'objets étrangers dans une ouverture.
- La HQ Capri doit uniquement être utilisée à l'intérieur dans un endroit non humide.
- La HQ Capri ne doit pas être rangée ou utilisée à des températures extrêmes.
- Utilisez la HQ Capri uniquement pour l'usage prévu indiqué dans ce manuel.
- Pour débrancher la machine de la prise murale, mettez l'interrupteur sur arrêt, puis retirez la fiche de la prise en tirant à partir de la fiche et non du cordon. N'utilisez jamais la HQ Capri si le cordon est endommagé ou ne fonctionne pas correctement. En cas de problème mécanique ou électrique, renvoyez la HQ Capri au centre de service agréé le plus proche ou au fabricant pour inspection, réparation ou réglage électrique ou mécanique.
- Il est déconseillé d'utiliser la machine à quilter HQ Capri avec un autre cadre de machine à quilter que ceux recommandés par Handi Quilter.
- Utilisez cette machine à quilter uniquement pour l'usage prévu décrit dans ce manuel. Utilisez uniquement les accessoires recommandés par le fabricant décrits dans ce manuel.
- Ne jamais utiliser la machine si des ouvertures d'air sont bloquées. Gardez les ouvertures de ventilation de la machine exemptes d'accumulation de peluches, poussières et morceaux de tissu.
- Ne pas utiliser là où des aérosols (vaporisateurs) sont utilisés ou de l'oxygène est administré.
- Ne pas tirer ni pousser trop fort la machine sur le tissu lors de l'exécution des points. Cela pourrait provoquer une déviation de l'aiguille et en entraîner la fracture.
- N'utilisez que les aiguilles conçues pour le quilting en piqué libre et recommandées par Handi Quilter pour cette machine. D'autres types d'aiguilles risqueraient de se fracturer au cours d'un quilting normal.

- Ne pas laisser les enfants jouer avec la machine. Une attention particulière est nécessaire lorsque cette machine est utilisée par ou à proximité d'enfants.
- Cette machine peut être utilisée par des enfants de 8 ans et plus, ainsi que par des personnes atteintes d'un déficit physique, sensoriel ou mental, peu expérimentées ou ayant peu de connaissances, à condition que ces personnes reçoivent les instructions de sécurité et la supervision nécessaires à l'utilisation de la machine et qu'elles comprennent les risques encourus.
- Les travaux de maintenance et de nettoyage ne peuvent pas être effectués par des enfants sans supervision.

Save These Instructions

This machine is intended for household or commercial use.

Disclaimer

Handi Quilter and its Retailers are in no way legally responsible or liable for damage to the HQ Capri when used improperly or not in accordance with the guidelines stated in this manual or when used on machine quilting frames not recommended by Handi Quilter.

Optional U.S. Grounding for Customers with 120 VAC Connections

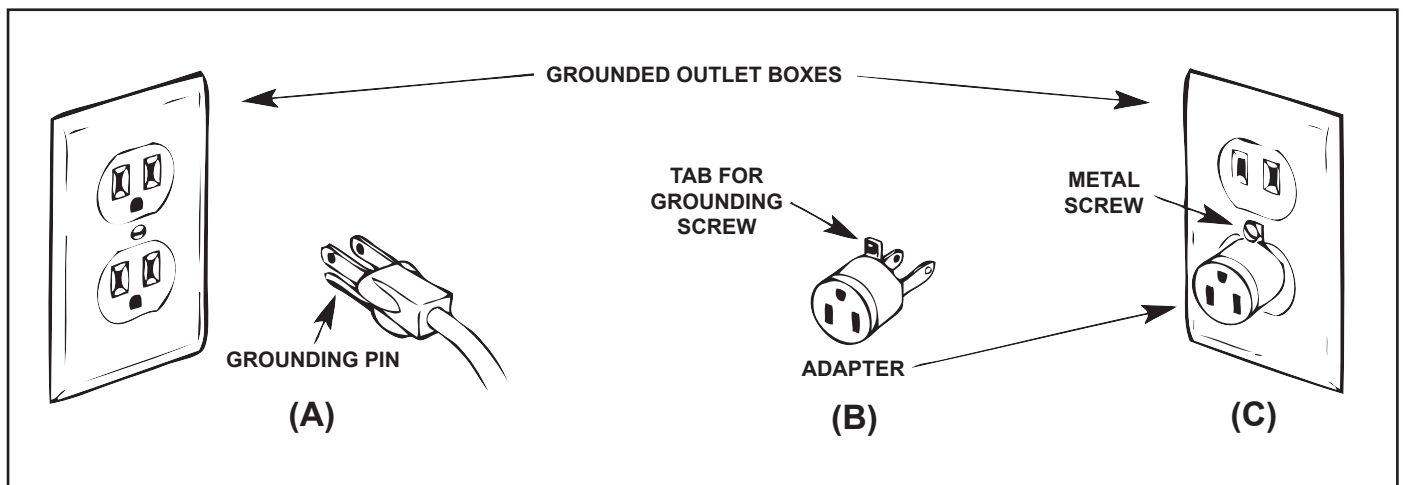

This product is for use on a nominal 120 V or nominal 220 V circuit, and has a grounding plug that looks like the plug illustrated in sketch A above. A temporary adapter, which looks like the adapter illustrated in sketches B and C, may be used to connect this plug to a 2-pole receptacle as shown in sketch B if a properly grounded outlet is not available. The temporary adapter should be used only until a properly grounded outlet can be installed by a qualified electrician. The green colored rigid ear, lug, and the like, extending from the adapter, must be connected to a permanent ground such as a properly grounded outlet box cover. Whenever the adapter is used, it must be held in place by the metal screw.

- ➡ **IMPORTANT:** In Canada, the use of a temporary adapter is not permitted by the Canadian Electric Code.

To Use the Machine Safely

1. Carefully watch the needle when sewing. Do not touch the hand wheel, take up lever, needle, or other moving parts.
2. Turn the machine off and unplug the cord in the following cases:
 - when you have stopped using the machine
 - when you replace or remove the needle or any other part
 - when you check or clean the machine
 - when you leave the machine unattended
3. Connect the machine directly to the wall outlet or to a surge protector that connects directly to the wall outlet. Do not use extension cords.

To Increase the Life of Your Machine

1. Do not store this machine in areas exposed to direct sunlight or high humidity. Never use or store the machine near a heater, an iron, a halogen lamp or other hot things.
2. Use only neutral soaps or detergents to clean the machine. Benzene, solvents and scouring powders can damage the case and the machine and therefore should never be used.
3. Do not drop or bump the machine.
4. Always consult the manual to replace or fix the hopping foot, needle or any other part of the machine. If necessary contact an authorized Handi Quilter retailer or Handi Quilter technical support.

To Repair or Adjust the Machine

If the machine breaks down or needs adjustment, first check the troubleshooting chart in the appendix to inspect and adjust the machine yourself.

For more product information and updates, visit our website at www.HandiQuilter.com.

The contents of this manual and product specifications are subject to change without prior notice. Check for updated manuals at www.HandiQuilter.com/manuals/.

About Your Machine

General Specifications

The HQ Capri utilizes high-tech electronics and an innovative touch-pad user interface to offer greater functionality and ease of operation to home quilters than ever before conceived in the quilting industry. The HQ Capri quilting machine is a high quality machine that incorporates very robust design features and is very easy to service.

Sewing Opening Dimensions	8.25" X 18" (210 mm X 457 mm)
Sewing Speed	Maximum: 2200 SPM
Needle System	134 (135 X 7)
Hook System	Rotary, Horizontal axis, M-class bobbin
Bobbin Type	Aluminum, Class M
Bobbin Case	Type MF
Motor Type	Brushless DC
Needle Positioning	Up and down, tie-off stitch
Electrical Power	US/Canada: 105 – 120 VAC, 47-63Hz, 300W peak Rest of the world: 100 – 250 VAC, 47-63Hz, 300W peak This machine conforms to UL and international safety standards for sewing machines and US and international laws for electromagnetic compliance.
Outlet Power	120 watts maximum
Sew Foot Stroke/Lift	5 mm
Needle Bar Stroke	35.3 mm
Take-Up Stroke	73 mm
Lubrication, main components	Kluber Lube, permanent
Lubrication of hook	Velocite 10, Texaco 22

Disclaimer

Handi Quilter and its Retailers are in no way legally responsible or liable for damage to the HQ Capri when used improperly or not in accordance with the guidelines stated in this manual or when used on machine-quilting tables not recommended by Handi Quilter.

HQ Capri Components

Front Side View

Components Not Identified

Because the HQ Capri is upgradeable to a stand-up frame quilting system, there are components found on the machine that are not used for stationary machine quilting (such as threaded holes for handlebars).

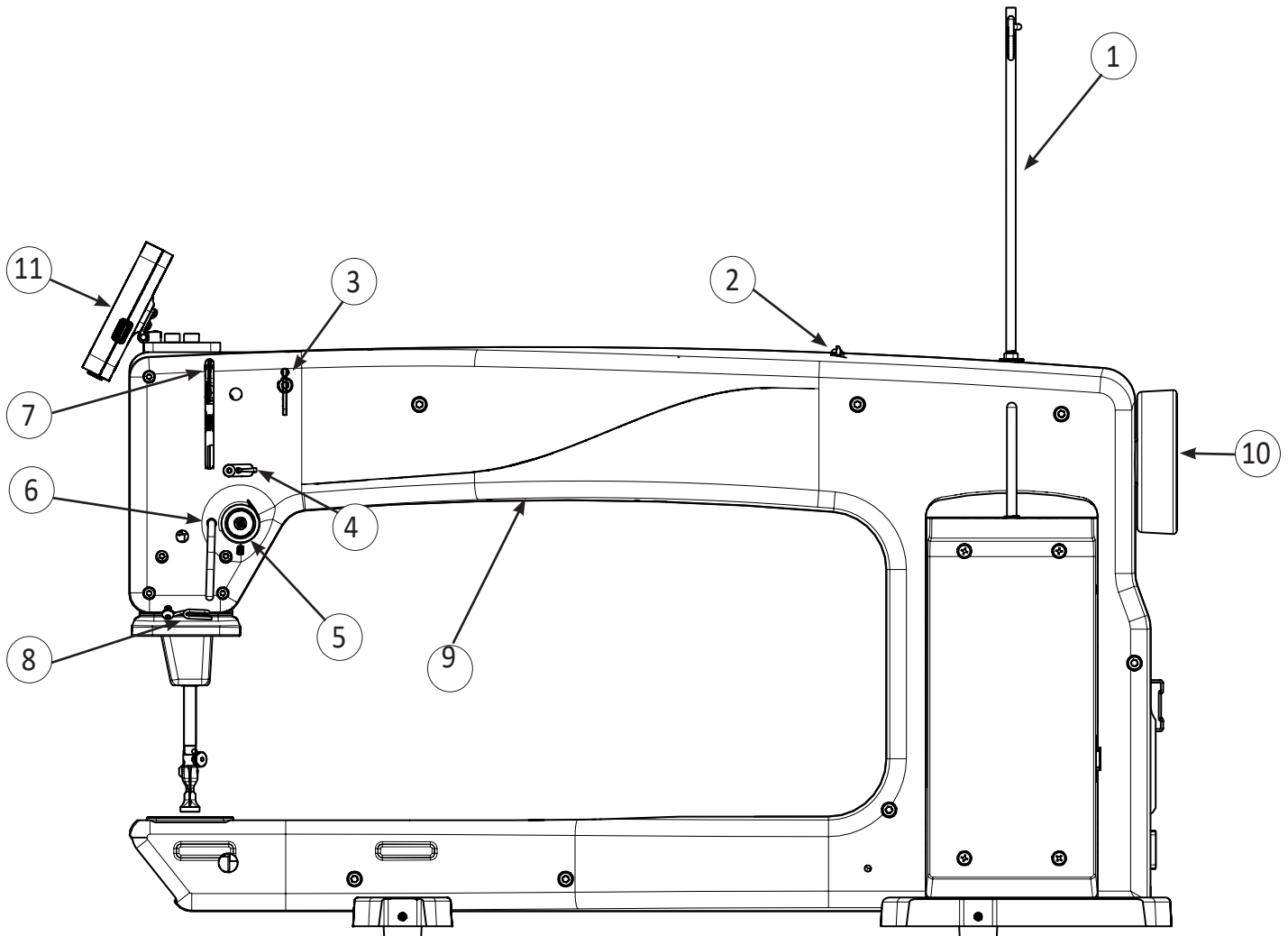

- | | |
|--------------------------------|-----------------------|
| 1. Thread Mast | 7. Take-Up Lever |
| 2. Thread Guide A | 8. Thread Guide E |
| 3. Three-Hole Thread Guide B | 9. Front Casing/Frame |
| 4. Thread Guide C | 10. Hand Wheel |
| 5. Top Thread Tension Assembly | 11. Display |
| 6. Stirrup Thread Guide D | |

Back Side View

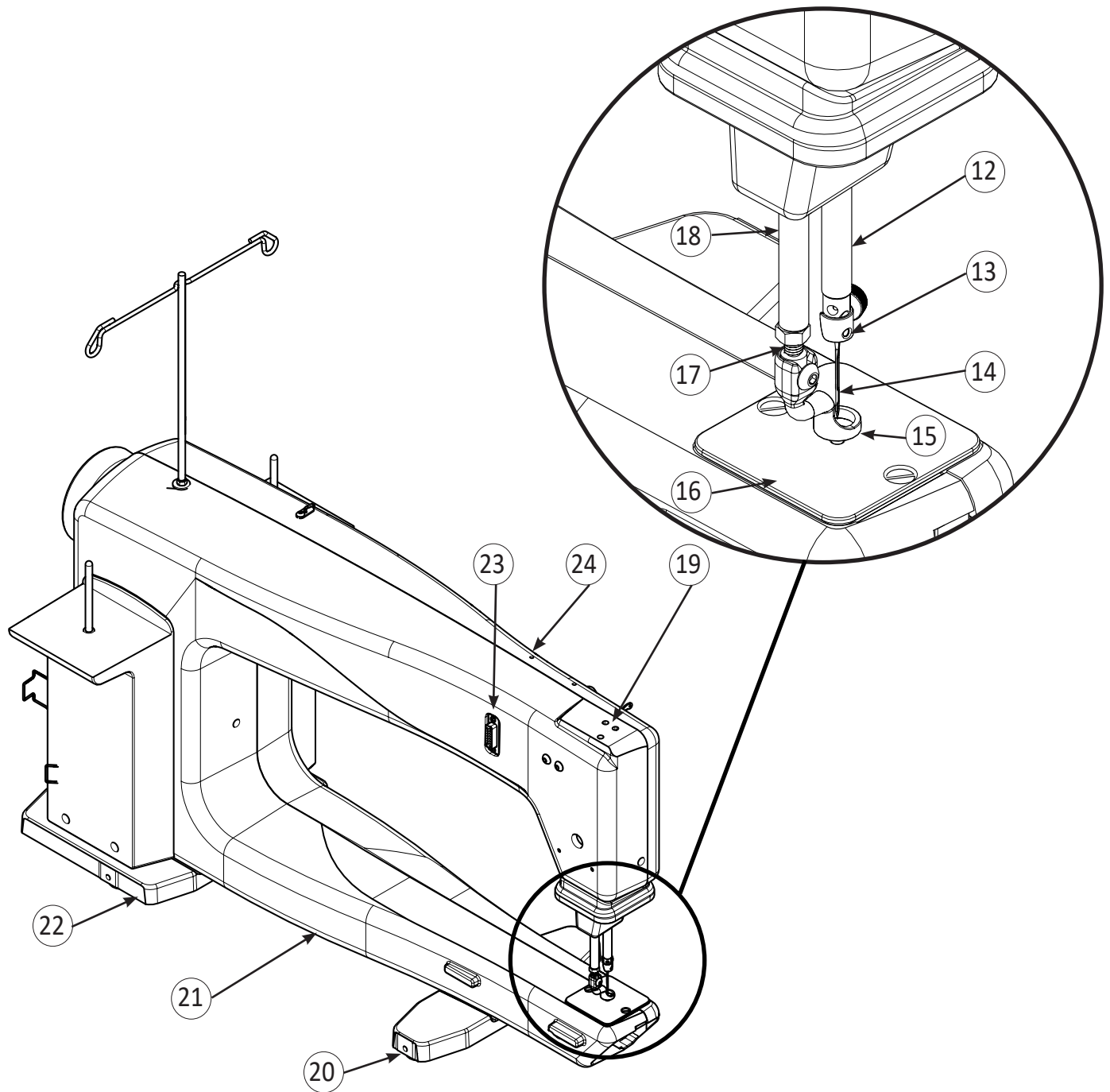

12. Needle Bar

13. Needle Bar Thread Guide

14. Needle

15. Ruler Foot

16. Needle Plate

17. Handi Feet mount

18. Presser Bar

19. Front Threaded Display Mounting Holes

20. Front Base

21. Back Casing/Frame

22. Rear Base

23. Color Touch-Screen Display Connector

24. Threaded Horizontal Spool Pin Mounting Hole

Rear and Front Views

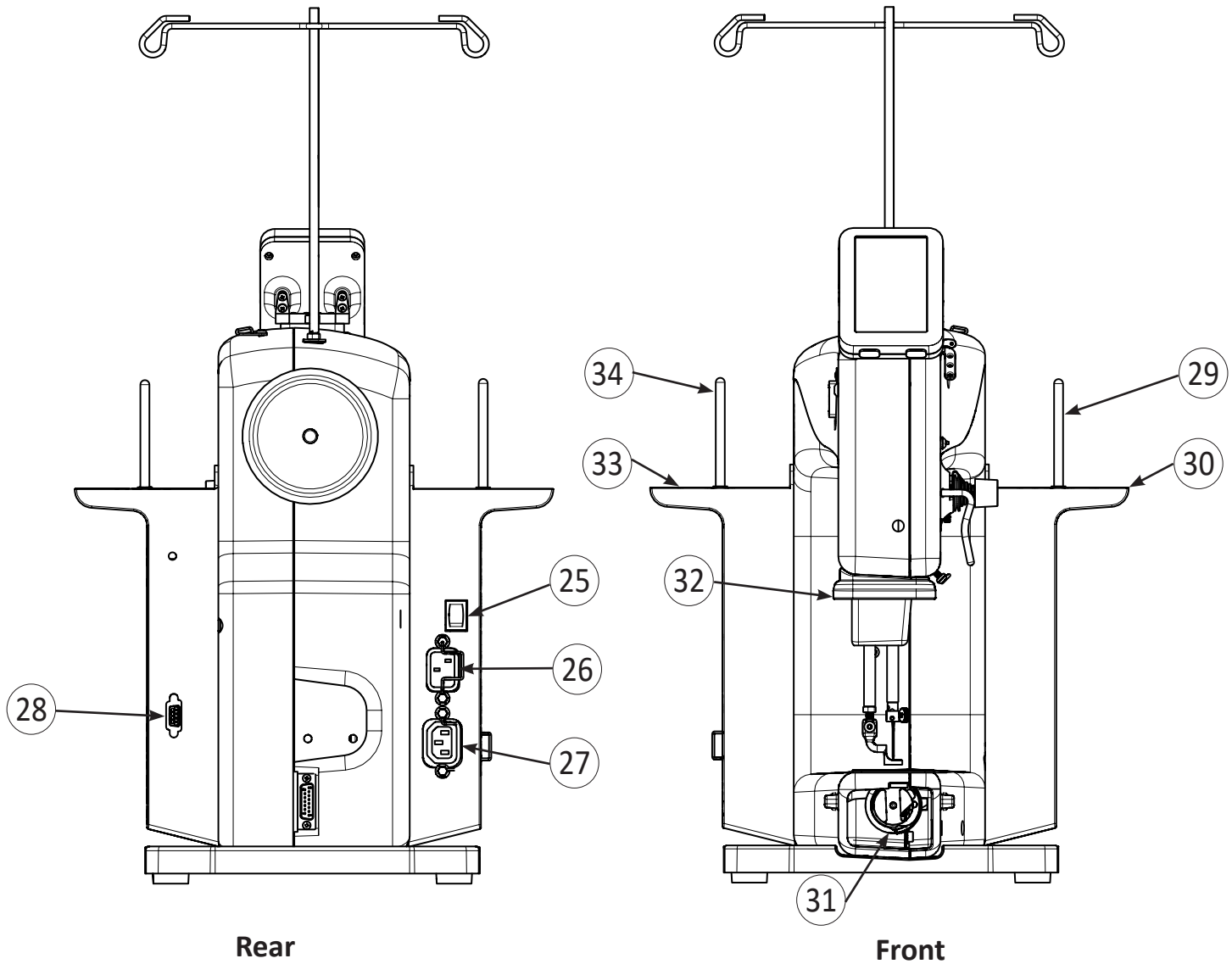

- 25. On/Off Switch
- 26. Power Cord Connector
- 27. Accessory Power Outlet
- 28. Foot Pedal Connector
- 29. Spool Pin 1

- 30. Electronic Control Pod (C-Pod)
- 31. Bobbin Assembly
- 32. LED Light Ring
- 33. Power Pod (P-Pod)
- 34. Spool Pin 2

Installation and Setup

Setting Up the Table

The HQ InSight™ Table is designed to accommodate the HQ Capri machine. It has legs that are height-adjustable and is heavy enough to provide stabilization for quilting at high speeds.

See the instructions provided with the HQ InSight Table for table assembly.

Placing the Machine in the Table

1. We recommend having someone help lift and place the machine.
2. Lift the machine by putting one arm through the throat space.
3. Remove the insert if in place and set the machine into the machine tray. Center the machine left to right in the opening.
4. Slide the insert into place and move the machine until it is aligned with the insert.
5. If necessary, adjust the machine plate to align the top of the insert with the table top. See HQ InSight Table Assembly Instructions for more information.

Installing the Power Cord

Check that the On/Off switch is turned off (the 0 setting). Plug the power cord into the top power outlet on the back of the machine. Do not plug the power cord into a power source at this time.

The lower power connector is available for powering future attachments as they are developed by Handi Quilter. (Not yet available.)



Installing the Foot Pedal

1. Plug in the foot pedal cord end into the foot pedal connector that is attached to the HQ InSight Table.
2. Place the foot pedal under the table where operator can reach it from the front of the machine.

Installing the Thread Mast

1. Locate the threaded hole on top of the machine near the rear by the hand wheel.
2. The thread mast comes with a washer and a nut. Remove the nut and washer, replace the nut onto the mast for five or six turns.
3. The washer protects the painted surface when the nut is tightened. Place the washer on the hole and insert the thread mast.
4. Turn the thread mast clockwise several revolutions, stopping when the mast eyelets are positioned directly over the spool pins.
5. Tighten the nut to secure the mast to the machine.

 **NOTE:** The eyelets of the thread mast **MUST** be centered over the spool pins. This ensures that the cone of thread will not pull, turn or tilt, which will cause thread tension problems.

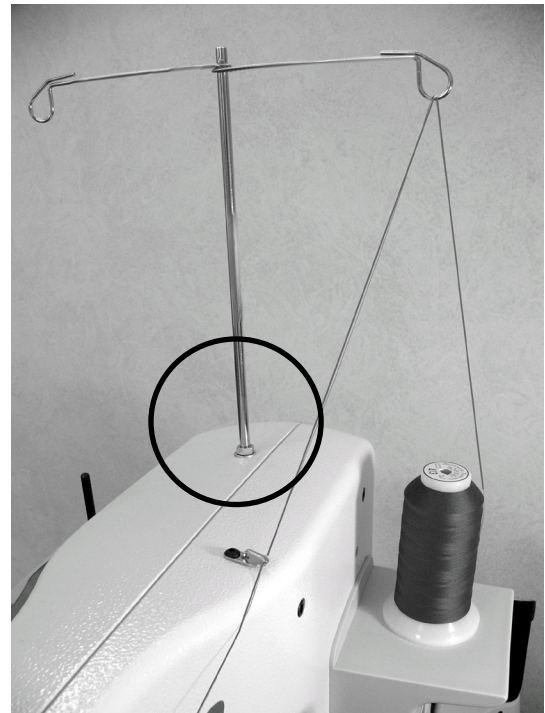

Installing the Color Touch-Screen

The color touch-screen comes pre-installed on its mounting bracket.

 **NOTE:** Confirm that the power is turned off before installing the color touch-screen.

1. Remove the two bolts from the bag in which they are packed.
2. There are three holes on top of the machine head. Only the two holes that are in line with each other are used. Ignore the third hole located to the side of these two holes.
3. Align the holes in the color touch-screen bracket with the two holes on top of the machine, with the touch-screen facing the needle end of the machine.
4. Use a 5mm Allen wrench to insert the two long bolts through the holes of the bracket and into the machine. Tighten in place.
5. Plug the remaining cable end into the display connector located on the side of the machine.
6. Remove the protective plastic from the touch-screen before using.



Using your Machine

Needle/Thread Selection Guide

Needle Size	Threads
12 (80)	Monofilament, 100 wt. Silk, 60 wt. poly, mylar
14 (90)	Silk (100 wt) 60 wt., monofilament, glitter, some metallics
16 (100)	60 wt., 50 wt., 40 wt., monofilament, glitter, metallics
18 (110)	50 wt., 40 wt., 30 wt., metallic
21 (125)	30 wt., 20 wt., 12 wt.

Changing the Hopping Foot

Your machine comes with two hopping feet: a ruler foot and an open-toe foot. Use the ruler foot for ruler work and everyday quilting, and the open-toe foot when you need greater stitch visibility (such as micro quilting).

1. Remove the foot that is on the mount by using the 2.5mm hex wrench to loosen the mounting screw far enough that you can slide the foot off of the mount.
2. Slide the desired foot onto the mount. Note that the opening on the side of the foot is lined up with the screw hole. Push the foot up as far as it will go.

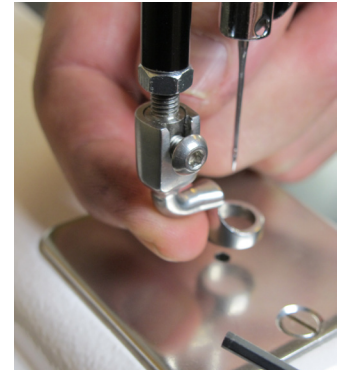

3. Tighten the foot firmly with the 2.5mm hex wrench.

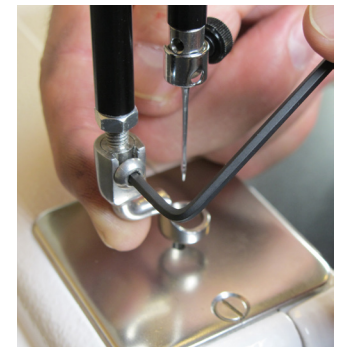

4. Ensure the middle of the foot opening is centered with the needle when the foot is fully tightened with the 2.5mm hex wrench. If it isn't properly centered, loosen the lock nut on the foot adaptor with an 8mm wrench, center the foot with the needle; hold the foot firmly in position; and tighten the lock nut.



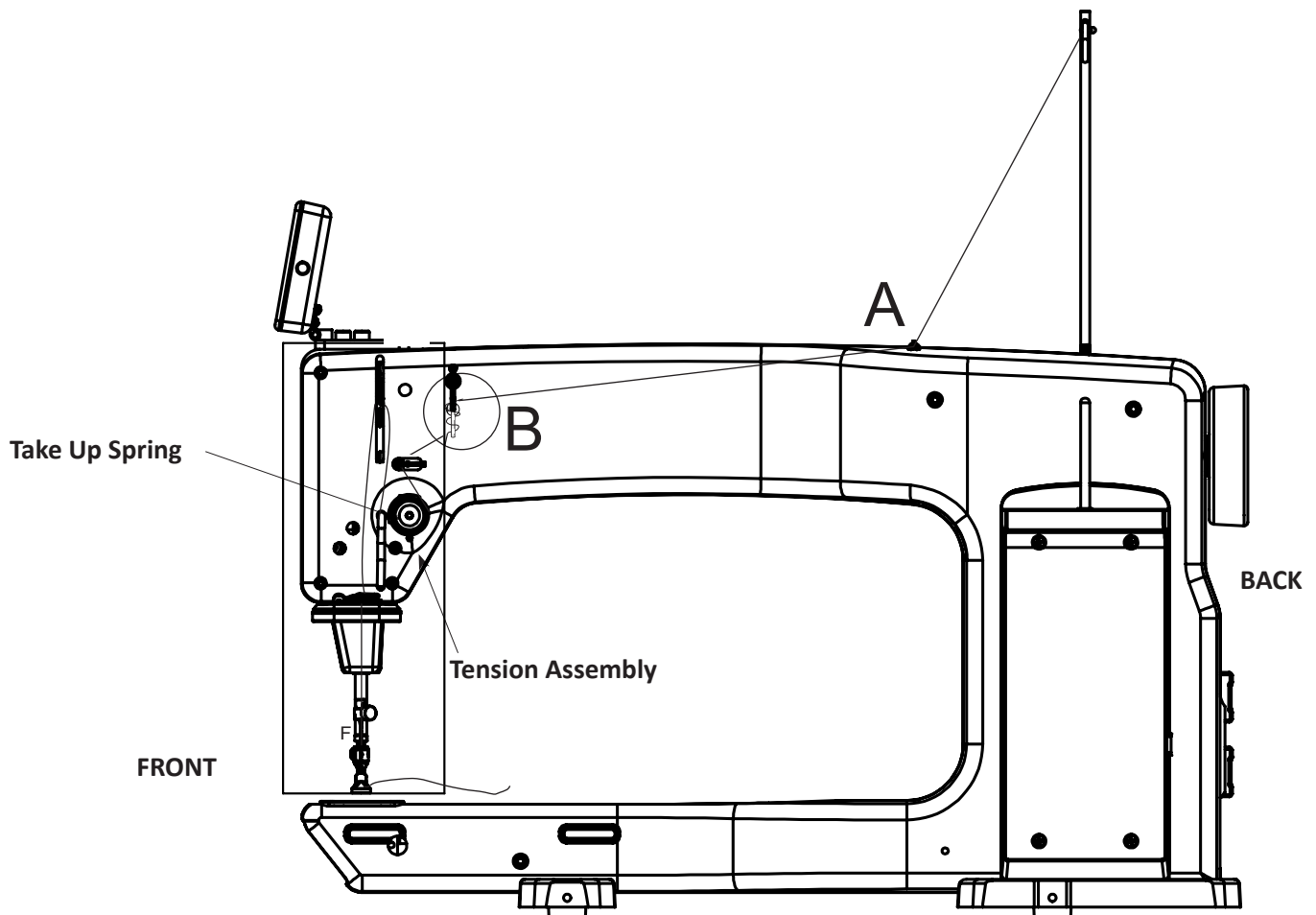

Threading the Machine

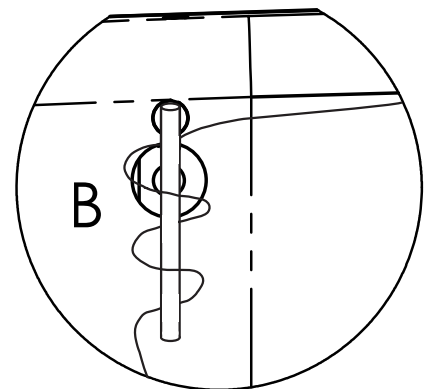

1. Place a cone or spool of thread on the spool pin. If using a spool, make sure that any slits on the spool are against the base of the spool pin holder. Pass the thread through the thread-mast eyelet from back to front, continuing to thread guide **A**.
2. Continue to the three-hole thread guide **B**. Beginning at the top, wrap all three holes from back to front, hand wheel side to needle side.

 **NOTE:** The purpose of the three-hole thread guide **B** is to prevent loops of thread coming off the thread cone from going into the top tension as a knot, causing thread breakage and bad tension. For most threads on a cone, it is important to thread all three holes for consistent results and to make adjustments at the top tension assembly. An exception to this rule is when working with very delicate threads, such as holographic or threads that are prone to breakage. You may try skipping one or two holes on thread guide **B** when using these threads.



 **NOTE:** Videos showing threading and other tips can be found on the USB stick included with this machine.

These videos are also available on www.HandiQuilter.com

3. Thread continues through thread guide **C**, and then down to the tension assembly.

 **NOTE:** It is important that the thread is “flossed” up between the two tension discs. If the thread is not firmly in place between the two tension discs, the thread rests on the outside of the tension discs (without tension) and looping on fabric or thread nests may occur.

4. Once the thread is in place, be sure that the thread catches on the take-up spring and then pull it down under the stirrup (thread guide **D**).

5. Bring the thread back up through the take-up lever from back to front, and then down through thread guide **E**. Pull the thread at the take-up lever to ensure that it is properly flossed between the tension discs. If it is properly flossed in the tension discs you should feel some resistance as you pull the thread. If it is not, then the thread will pull freely.

6. Pull the thread down to the needle thread guide and thread through the hole (thread guide **F**).

7. Make sure the thread is following the groove down the front of the needle and threads from front to back. Be careful that the thread does not twist around the needle.

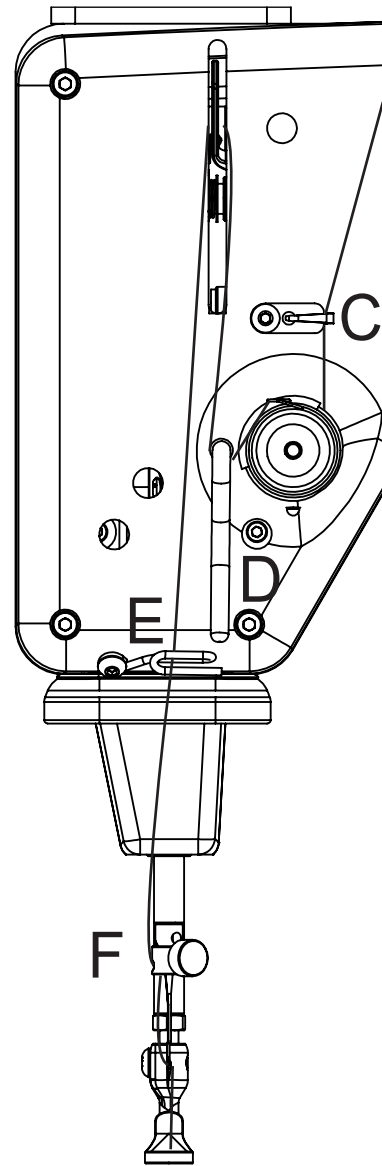

 **IMPORTANT:** The HQ Capri quilting machine does not have a presser foot lever or top tension release like a home sewing machine. On a home sewing machine, the top tension is released when the presser foot is raised, allowing the thread to come freely out of the machine.

When a home machine is threaded, the presser foot is raised, and the tension discs are released and open for the thread to easily fall between the tension discs. This is not the case with the HQ Capri quilting machine, where the top tension is always tight and the tension discs are never open.

Therefore, the thread must be pulled up or “flossed” between the tension discs, or it will stay outside the discs and float without tension, causing serious stitch problems and/or thread nests. It is also possible to bend the needle while it is threaded if care is not taken while moving the quilt across the quilting table because the top tension is never released.

Inserting (or Changing) the Needle

The needle that is in the machine when it arrives at your home has been used for 20 minutes of testing. It is possible that it could be damaged in shipping or as you remove the machine from the box. For these reasons, Handi Quilter recommends that you replace the needle before beginning to quilt with your new machine.

1. Move the needle bar to the highest position by turning the hand wheel. Then turn off the power.
2. Loosen the needle-bar-clamp screw.
3. Remove the old needle by pulling it down. Discard the old needle in a safe way.
4. With the scarf (small ground out section/dip on the back side of the needle just above the needle eye) facing toward the back, hand-wheel side of the machine, and the long groove down the front of the needle facing the bobbin case side, push the needle all the way up into the needle bar, until it can go no farther and you can see the top of the needle touching the top of the sight hole.
5. Carefully tighten the needle bar clamp screw until the needle is securely fastened into the machine. Use the 2.5mm hex tool to secure the needle; however take care not to over tighten the screw. This may result in damaged or stripped threads in the needle clamp. Damage to the needle clamp may also make it difficult to fully insert the needle, which will change the machine timing, causing more issues. Stripped threads and damage caused by improper needle installation or tightening are not covered under warranty.

 **NOTE:** It is recommended to use a new needle for each new quilt. Also, replace the needle any time it becomes bent, dull or burred.

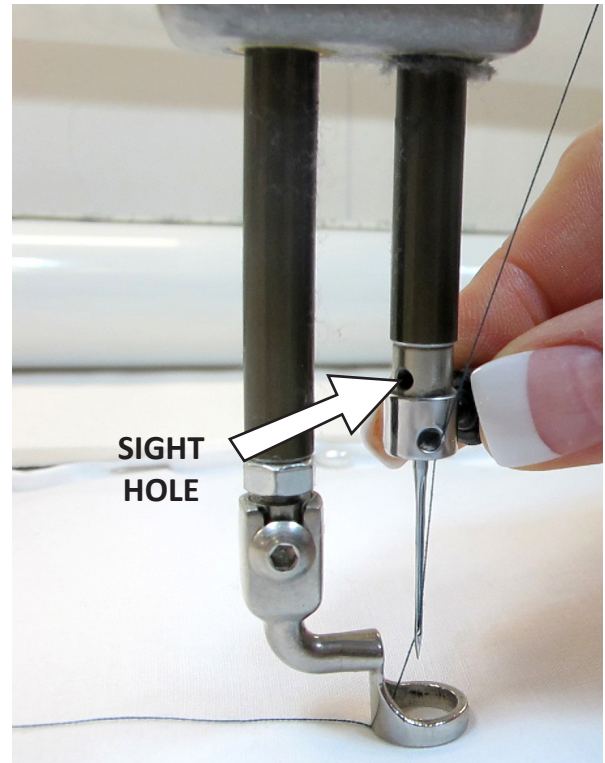

➡ **IMPORTANT:** Check the needle to confirm it is fully inserted. The needle bar has a stop/sight hole above the needle bar clamp screw. Make sure the needle is touching the top of the stop/sight hole. If it is not, the machine timing will be off and it may be possible for the needle to collide with internal parts, causing damage not covered by warranty.

⚠ **CAUTION:** Your Handi Quilter machine stitches at a much faster speed than your home sewing machine, therefore, it is essential that the needle is seated into the needle bar and fully tightened (but not over tightened). Check often that the needle has not become loose. If the needle comes loose, it could break in the machine, causing damage, altering the machine's timing, or causing bodily harm.

Needles are inexpensive and are important to the success of your project. Plan to change needles every 5-7 hours of quilting or more often if working with fusibles or heavy materials.

Bobbin Case and Bobbin Thread Tension Adjustments

Inserting the Bobbin

 **NOTE:** Turn off the power switch while inserting the bobbin case or anytime your hands are near the needle area.

1. Place the bobbin in the bobbin case so that the thread pulls off clockwise when viewing the open side.
2. Slide the thread through the slot and under the tension spring leaving 5-6 inches of thread hanging loose.

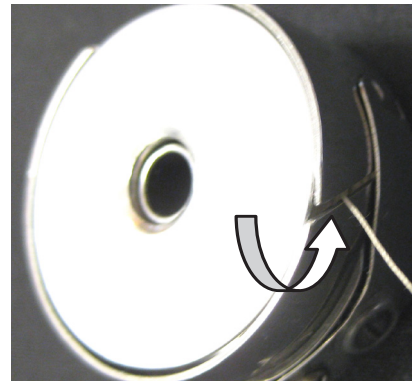

3. To insert the bobbin case into the machine, grasp the bobbin case with thumb and first finger. Do not lift the lever on bobbin case. Fit the bobbin case onto the hook spindle in the machine. Rotate the case until the open throat keys into the alignment notch in the middle of the hook. Push the case in until it stops in place. Push the case inward further until it clicks. Allow the thread end to hang freely.

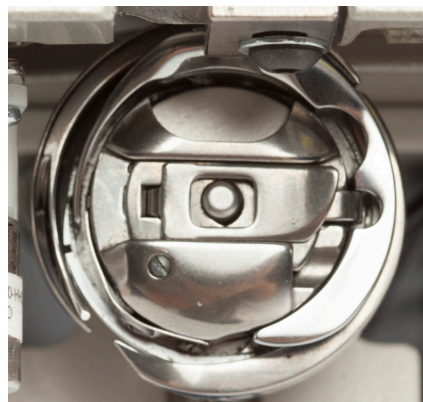

 **NOTE:** Pulling out the latch lever pushes the bobbin forward in the bobbin case, aiding in removal of the bobbin. The lever should be used only for removing the bobbin case from the machine.

 **NOTE:** Bobbin tension and other tips can be found on the USB stick included with the machine. Videos showing adjusting. These videos are also available on www.HandiQuilter.com.

Drawing The Bobbin Thread to the Top of the Quilt

1. After threading the machine, plug it in and turn on the power. Place quilt sandwich under hopping foot.
2. While firmly holding the tail of the needle thread with the left hand, choose one of the following methods to cycle the needle through one full rotation to bring the bobbin thread to the top of the quilt.
 - A. Foot Pedal Method. **LIGHTLY** tap the foot pedal to make the needle go down. Then **LIGHTLY** tap again to bring the needle up.
 - B. Needle Up/Down Button Half-Stitch. Find the Needle Up/Down Button in the center of the color touch-screen main display. Press once to cycle the needle down. Press again to cycle the needle back up.
 - C. Needle Up/Down Button, Full-Stitch. Find the Needle Up/Down Button in the center of the color touch-screen main display. Press and hold briefly to cycle the needle through one complete stitch cycle (down and back up).
3. Pull the fabric 3-4 inches away while holding the needle thread.
4. Bobbin thread will pull up and through to the top, allowing you to grasp the loop and pull it to the desired length.

Checking and Adjusting Bobbin Case Tension

The bobbin case tension is the foundation tension for the entire machine. To test that bobbin tension is correct, hold the bobbin case in the palm of your hand with the open end facing up. Wrap the thread around your index finger and lift the bobbin case from your hand. While gently moving the finger front to back (not up and down, which is not consistent), the bobbin case should slide slowly down the thread, like a spider on its web.

The small screw in the center of the tension spring is where the adjustment is made. Turn clockwise to tighten and counter-clockwise to loosen the bobbin case tension. Make very small adjustments. **Check the bobbin tension every time a new bobbin is inserted.**



Tighten Bobbin Case Tension

The bobbin case tension is **TOO LOOSE** if it will not lift up onto its side. Turn screw clockwise to tighten. The bobbin case screw requires very small adjustments. Think of the “tick of a clock”. Adjust, then check. Adjust and check again.

Easy-Set Tension™ Adjustment

- **IMPORTANT:** Top thread tension should be adjusted only after the bobbin case foundation tension adjustment is made.

Puckering, gathers and thread breakage occur when the top tension is too tight. Loops and thread nests occur on the back when the top thread tension is too loose. Tension may need to be adjusted, depending on the fabric, thread or batting used in each project.

As you change the top tension, the value in the tension indicator box on the Main screen increases or decreases in increments of five. When you are happy with the tension, note the top tension value for that type of thread (brand, weight, and color) so you can quickly and easily set the tension when you use this thread again in the future.

Unlike the bobbin case adjustment, which requires minute adjustments, the top tension knob may require turns anywhere from 1/4 of a turn to two to four turns to achieve balanced tension.

Tighten Top Thread Tension

To adjust the top tension tighter, turn the top thread tension knob **clockwise**.

Loosen Top Thread Tension

To loosen the tension, turn the top thread tension knob counter-clockwise.

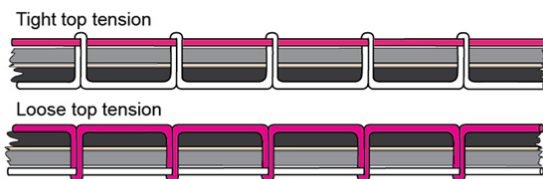
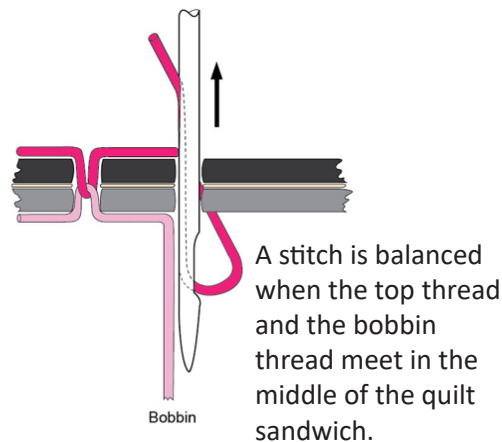

- ✍ **NOTE:** Before adjusting the top tension, remember to floss or pull the top thread up into the tension discs or it will float outside the discs providing little or no top tension. This could cause significant tension or nesting problems on the bottom side of the quilt. If the top tension is too loose (causing loops of thread on the underside of the quilt) and no amount of tightening the top thread tension knob seems to affect it, there's a good chance that the thread is riding on the outside of the tension discs and is not "flossed" between them.

Maintenance

 **NOTE:** Turn off the machine and remove the power cord when performing maintenance on the machine.

Cleaning and Lubricating the Machine

Only use light sewing machine oil in the HQ Capri. Internal oiling is not necessary on the HQ Capri except when the machine is taken to a service technician for routine maintenance and cleaning. The hook assembly, however, needs regular lubricating. Failure to keep the hook assembly lubricated can cause severe damage to the machine.

To lubricate, turn off the machine. Remove the bobbin and case before oiling. Clean around the hook assembly with a soft brush to remove lint. Put a very small drop of oil on the hook in the region where the bobbin basket assembly and the rotating hook meet. The bobbin basket is the portion of the hook that the bobbin case snaps into. The bobbin basket remains stationary while the hook rotates around the basket. The oil lubricates the region where these two components interlock. A drop of oil in the region indicated will work its way back into the interlocking area of the hook and bobbin basket.

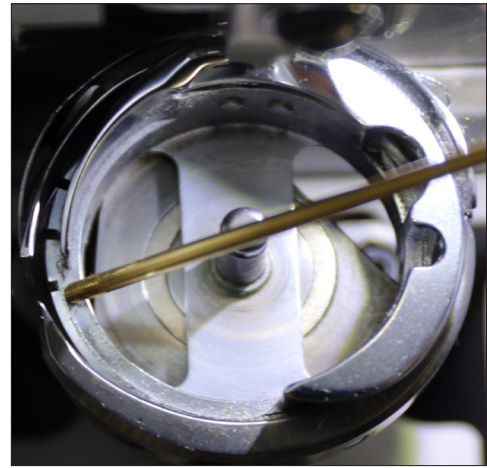

The frequency of lubrication depends upon the usage of the machine. Lubricating is recommended before running the machine if it has not been used regularly, or every other bobbin change if used frequently. After oiling, always stitch through a scrap piece of fabric, as oil may cling to thread. Over-oiling can cause excess dripping from the bobbin assembly. Lack of lubricant may be noticed by a change in the sound of the machine and will affect stitch quality.

Cleaning the Touch-Screen Display

Use a soft rag dampened with isopropyl alcohol to gently wipe the display and remove any marks. Never use any other chemicals to clean your display as they may adversely affect the touch-screen response and clarity.

Using the Touch-Screen Display

 **NOTE:** Review the Handi Quilter “Getting Started” USB for interactive instruction on the HQ Capri menu functions.

The HQ Capri has a color touch-screen display on the front of the machine. Settings are changed using this display.

Main Screen Manual Mode Button Functions

The Machine is in Manual Mode when the M is green.

(A) Pause/Play Indicator

The **Pause/Play** button on the bottom right of the screen may be used to start and stop the machine instead of the foot controller. When the button is pressed, the machine will start even if the foot controller is not pressed, and the symbol on the button will change from the play arrow to a double line pause icon. The button color will also change to green. When the button is pressed again, the machine will stop and the symbol on the button will change back to the play icon with a blue background color.

When the machine foot controller is pressed, the button color and icon show that the machine is running by changing the button to the pause icon and green background. When the foot controller is released, this button will return to the blue button with the play icon.

(B) My Speed

My Speed Indicator is the current selected maximum speed the machine will run when the foot pedal is fully depressed. The value displayed will vary as you press and release the foot pedal. The maximum stitches per minute that is displayed is controlled by this limit that is set for the machine.

(C) Limit Controls

The **Limit Controls** encompass two main features, the **My Speed** controls and **Preset** buttons. The My Speed controls consist of “+” and “-” buttons and the white My Speed display box. Pressing the “+” button will increase the maximum motor speed the pedal controls. Pressing the “-” button will decrease the maximum speed.

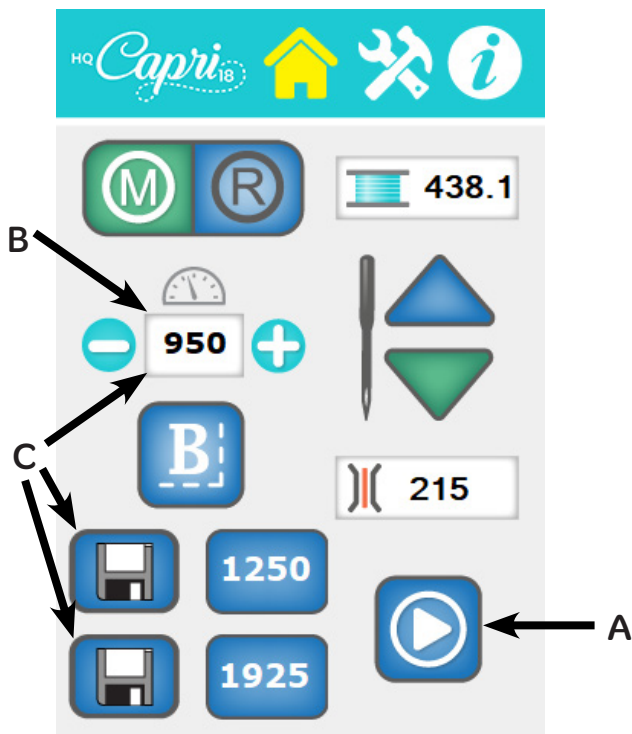

(D) Presets

Save up to two preset speeds to quickly switch between speed preferences. For example, you may prefer a slower speed when using rulers and a faster speed when doing all-over meandering.

Use the “+” and “-” buttons to adjust the speed percentage and then press the **Record** button next to one of the preset values to store that speed as a preset. To use one of the preset speeds, simply press the speed.

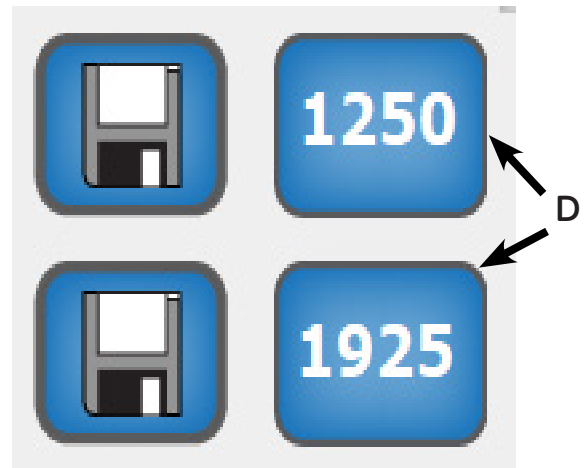

(E) Basting Mode In Manual Operation

The HQ Capri has a basting mode that causes a stitch to be formed at a specified time interval – every 0.5 second, 0.75 second, 1.0 second, 1.5 second, or 2.0 seconds. Touch the basting icon to activate basting mode. Then press the “+” or “-” button to set the time interval for the basting stitch.

Press the foot pedal to begin quilting. The HQ Capri will take a stitch (needle down and then needle up) at the specified interval. Coordinate how quickly you move the quilt sandwich with how quickly the machine takes a basting stitch. Experiment with the various speed options along with moving the quilt to find which of the settings work best for you to position the basting stitches on your quilt.

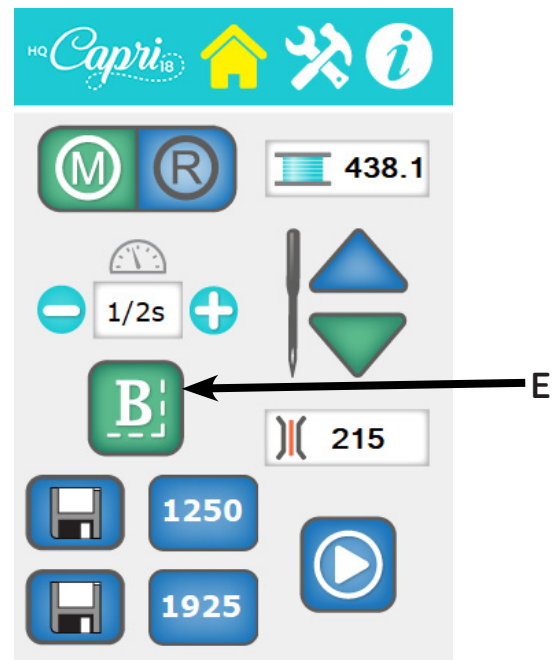

(F) Easy-Set Tension

The tension box on the Main Screen shows the current tension setting as a numeric value. As the tension dial is turned clockwise to tighten the top tension, the number increases in increments of five. As the tension dial is turned counter-clockwise to loosen the top tension, the number decreases in increments of five. The faster the dial is turned, the faster the numbers increase or decrease.

After setting the bobbin tension, test the top tension by stitching on a fabric scrap on the edge of the quilt batting and backing. Increase or decrease as needed until balanced tension is achieved. Make a note of the thread type (weight, brand, color) and the tension value to quickly and easily set the tension when this same thread is used again in the future.

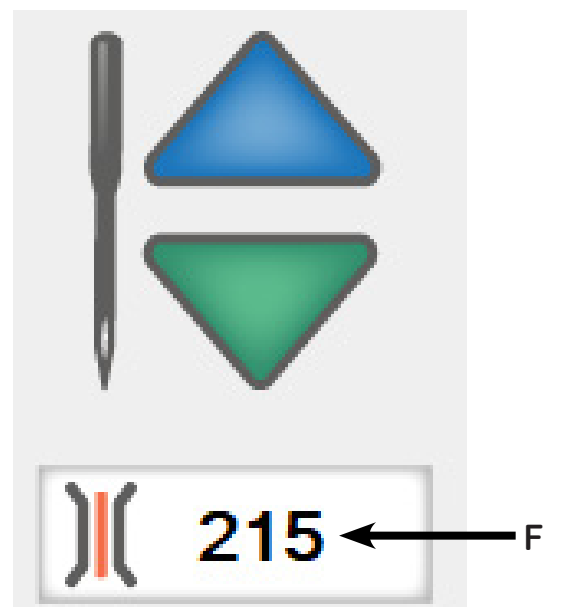

(G) Bobbin Thread Indicator

When using the Low-Bobbin Estimator feature, The **Bobbin Thread Indicator** box shows how much bobbin thread remains on the bobbin. The value counts down until it gets to zero, at which time the low-bobbin alarm sounds an alert indicating it is time to put in a new bobbin. When recording a bobbin length, **REC** will appear in this box. When recording is turned off, the bobbin remaining value will again appear in this space.

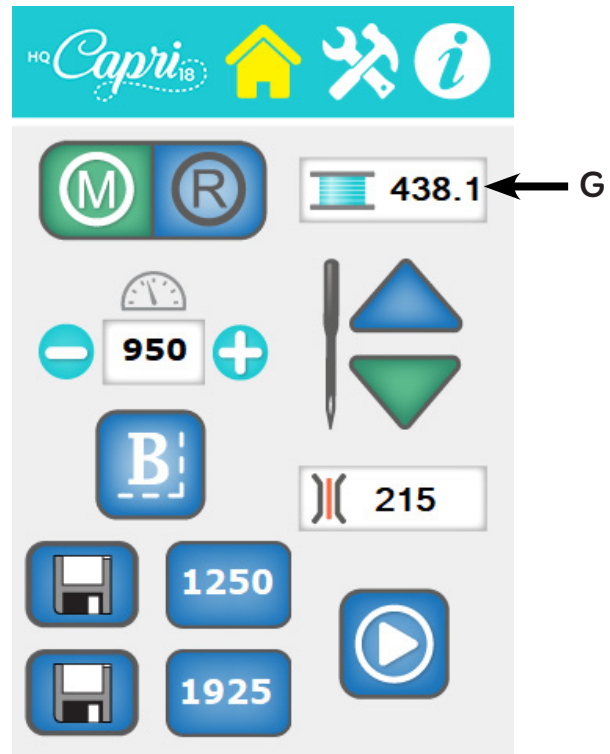

(H) Needle Stop

Needle Stop setting indicates whether the needle stops in the up or down position. Green indicates the selected button.

The Needle Stop buttons indicate the position the needle will stop, up or down, when the foot pedal is released or the **Play** button is turned off.

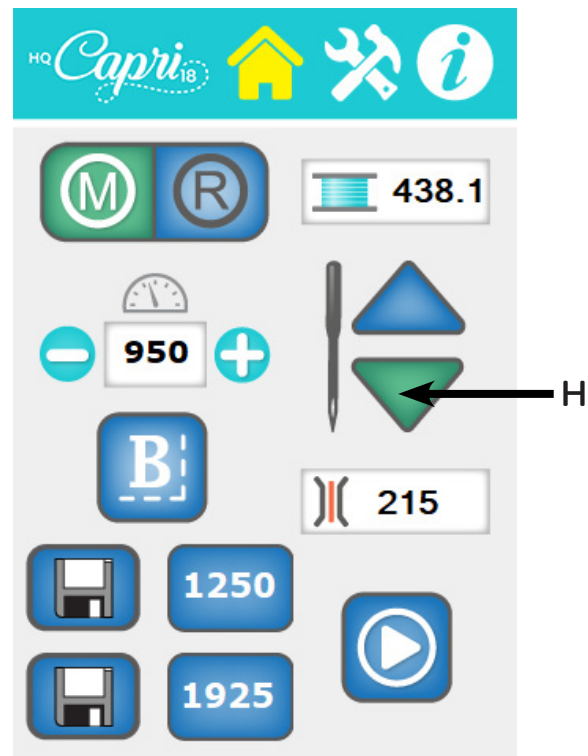

(I) Up/Down/TieOff

The arrow buttons can assist in creating tieoff stitches, basting, or needle-positioning functions without the use of the foot pedal. Pressing and releasing the arrow button quickly will send the needle to the next needle stop position. If the needle is up, pressing the button will cause the needle to move to the down position. If the needle is down, it will return to the up position.

Pressing and holding the green arrow button for a longer time creates a full stitch. The needle will continue to cycle while holding the arrow button and stop when the button is released. This action is useful for tying off beginning and ending stitches.

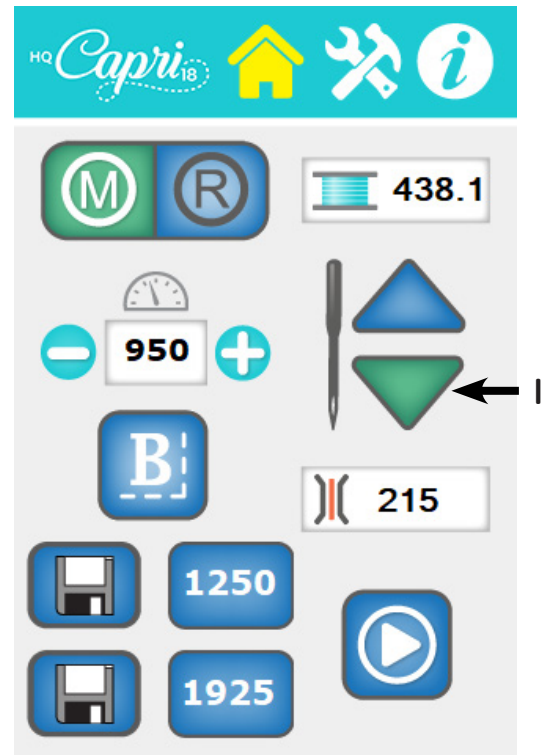

Main Screen Regulated Mode Button Functions

The Machine is in Regulated Mode when the R is green.

Stitches Per Inch (SPI)

Pressing the “+” or “-” buttons in the mid left portion of the screen will increase or decrease the stitches per inch (SPI) setting. The setting is reflected in the white indicator box between the “+” and “-” buttons. The value can be adjusted between 4 and 22 stitches per inch.

Basting Stitches

There are four basting stitch settings controlled by the stitches per inch function. After the SPI reaches its lowest setting of 4 stitches per inch, pressing the “-” button will activate the basting settings:

- 0.5-inch baste (one stitch every half-inch movement of the fabric over the table)
- 1-inch baste (one stitch every one inch movement of the fabric over the table)
- 2-inch baste (one stitch every two inches of movement of the fabric over the table)
- 4-inch baste (one stitch for every four inches of movement of the fabric over the table)

After selecting the basting stitch setting, begin quilting by pressing the **Play** button or by pressing down on the foot pedal. As the fabric moves across the table, the machine will perform a stitch (needle down and needle up) every half inch, one inch, two inches or four inches.

The stitch regulation mode (Precision or Cruise) which is selected will be indicated by the button being green.

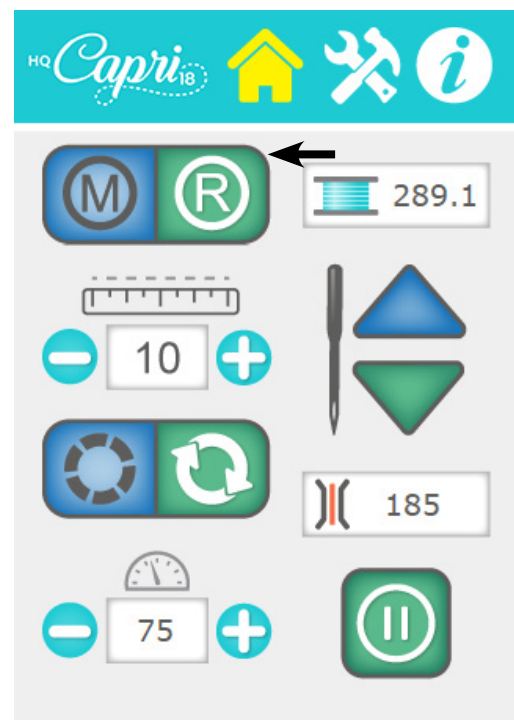

Precision

If **Precision** mode is selected, the HQ Capri will not start stitching until fabric moves across the table.

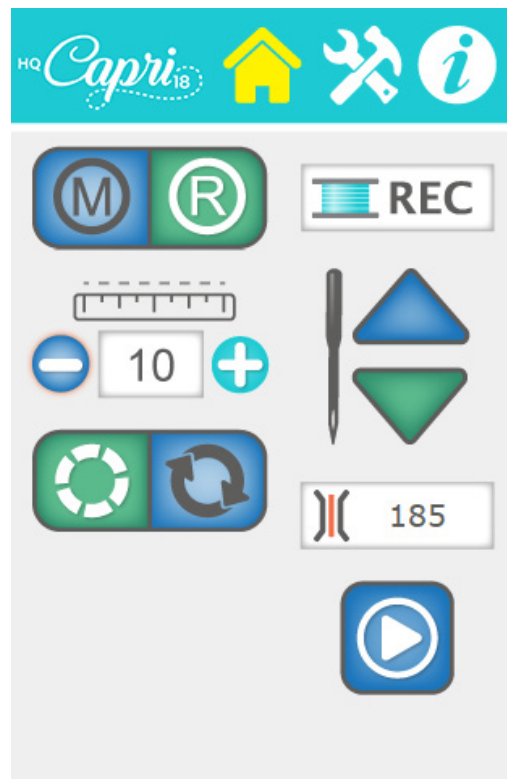

Cruise

If **Cruise** mode is selected, the machine will immediately begin stitching at the speed (stitches per minute) indicated in the box when the foot pedal is depressed or the play button is selected.

The Cruise speed is the minimum speed the machine will stitch, regardless of how slowly the fabric is moving across the table.

The Cruise speed can be adjusted using the “+” and “-” buttons that appear below the Cruise button when Cruise mode is selected. Cruise speed can be adjusted between 50 and 1,100 stitches per minute.

The **Play/Pause** indicator will change as soon as you press it or the foot pedal. In **Precision** mode, the needle will not move until the fabric moves across the table. In **Cruise** mode, the needle will stitch immediately at the Cruise speed as soon as you press the **Play** button or on the foot pedal.



Tools Menu

The Tools menu allows access to other functions available on the HQ Capri.

Low Bobbin

The HQ Capri includes a low bobbin alarm to estimate how soon the bobbin thread will run out.

Timer and Stitch Count

Track the time and stitch count per quilt project.

Alarms

The machine has two alarms. The first is the over-speed alarm in regulated mode, and the second is the timer alarm.

Lighting

For selecting light ring, light bar, and setting their brightness levels.

Calculator

An on-screen calculator may be accessed from the **Tools** screen.

Diagnostics

The Diagnostics button activates the screen where machine diagnostic functions can be performed. Diagnostic functions are generally only used when working with an authorized Handi Quilter retailer to resolve issues.

Set Language

The HQ Capri screens can appear in English, French, German, or Spanish. On the Tools Screen, press the lower left icon to cycle between English, Français, Deutsch, and Español.

Update

This is used for updating the display, machine, or sensor code.

Main

Press the **Home** button to return to the Main menu screen.

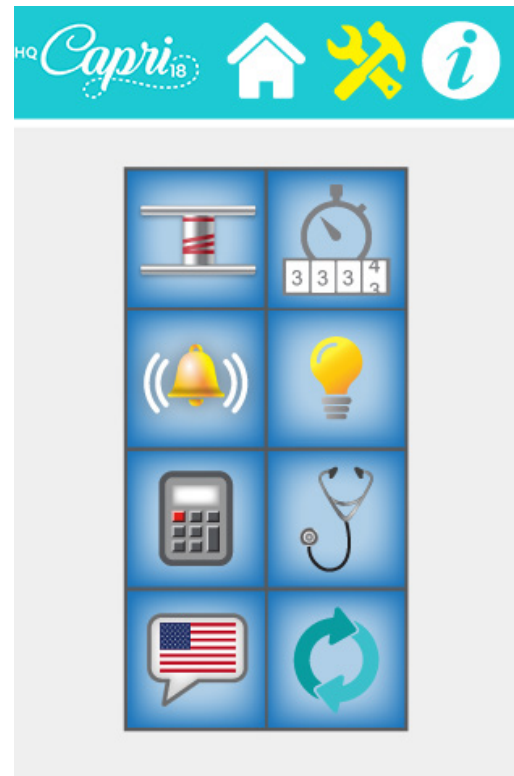

Low Bobbin

The HQ Capri includes a low bobbin alarm to estimate how soon the bobbin thread will run out. This low bobbin capacity is based on an estimate of how much of a particular thread can fit on a bobbin, in combination with other quilting factors such as tension, stitches per inch, and how much bobbin thread is used to pull up and tie off when beginning and ending quilting.

To estimate how much thread is on a bobbin, place a full bobbin in the machine, press the red Record button “A”, and quilt as usual.

When the bobbin runs out, press the top left button to Stop Recording. Note the number that is indicated under the Bobbin Thread Capacity “B”. Use the “-” button to reduce the number by 15 to 20 so the alarm will sound before the bobbin runs out. Save the reduced number as one of the Bobbin Thread Capacity Presets “D”. Make a note as to which type of thread the preset represents.

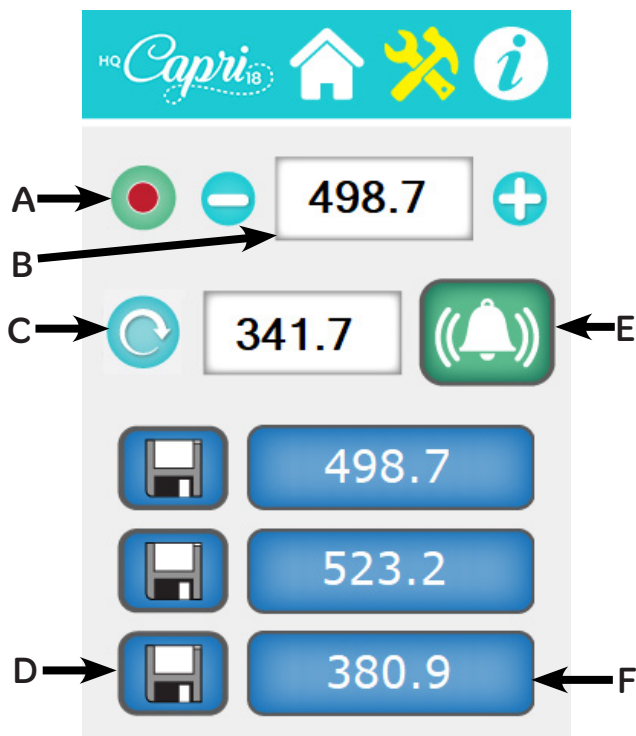

BUTTON ICONS:

- A = Record/Stop
- B = Bobbin Thread Capacity
- C = New Bobbin
- D = Save Preset
- E = Set Alarm
- F = Preset Value

Put a new bobbin with the same thread into the machine and press the New Bobbin button “C”. Then press the Alarm button “E”. As you quilt, the remaining bobbin thread value will estimate how much thread remains on the current bobbin, and when you reach the capacity value, an alarm will sound warning that the bobbin is nearly out of thread.

When operating in manual mode, the low bobbin function assumes stitching at approximately the last SPI setting on the regulated screen. If the SPI setting was below 8 stitches per inch, the function will assume you will quilt at 10 stitches per inch. It is advisable therefore to set the stitches per inch, on the regulated screen before you change to manual mode.

Three Bobbin Thread Capacity preset values can be stored – one for each of three different types of thread. Simply go through the record process with a full bobbin of that type of thread and then store the capacity as a preset. Press the corresponding preset button “F”, insert a full bobbin with that type of thread, and press New Bobbin button to start.

Timer and Stitch Count

Use the quilting timer to keep track of how much time is spent on a quilt. When beginning a new project, press the **Reset** button. Then press the **Play** button to begin recording quilting time. The timer records only when the machine is quilting. The time is saved even when the machine is turned off. When beginning another quilting session, quilting time is added to the timer. Press **Reset** to zero-out the timer and begin a new timing session.

Use the stitch counter to count the number of stitches in a quilt. Press the **Reset** button to zero-out the counter when starting a new quilt. To see the lifetime stitch counter for the machine, see the Information screen.

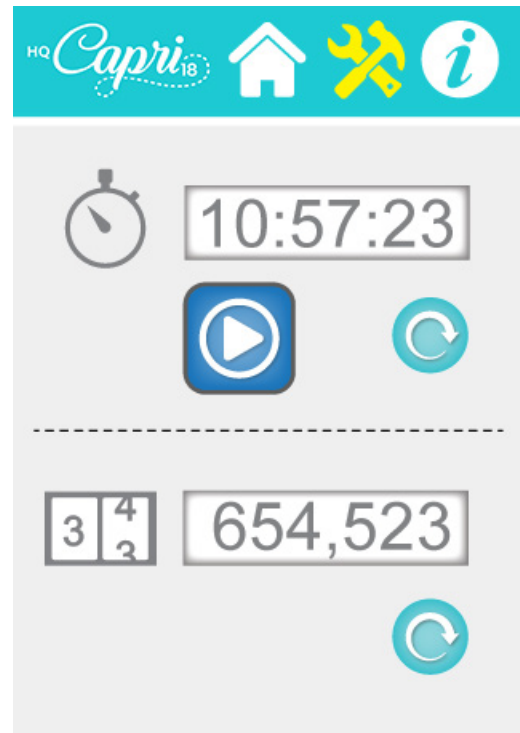

Alarms

The HQ Capri has alarms that can be turned on or off.

The overspeed alarm is enabled by pressing the alarm button next to the speed icon. It only functions in regulated mode. When enabled, an alarm will sound if the machine is being moved too fast to properly maintain stitch regulation.

The timer can be set to any amount of time as a convenient reminder. When the alarm button below the time value is pressed, an alarm will sound when the set time has expired.

Adjust the time using the “-” and “+” buttons next to the alarm button.

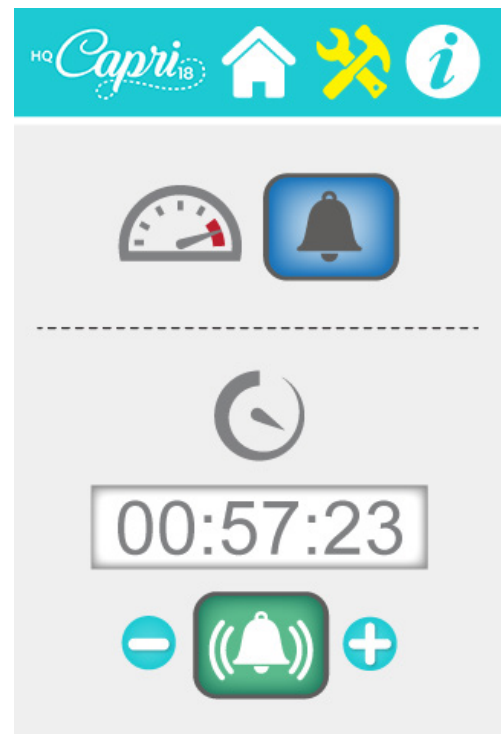

Lighting

The brightness portion of this screen has two buttons and a sliding control. The LED Light Ring and light bar can be turned on or off with the switch button associated with the LED location. Use the slide bar to adjust the brightness of each light.

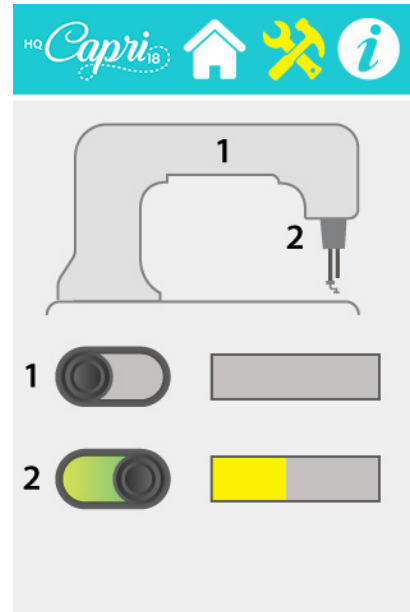

Calculator Screen

A basic six-function calculator is provided. The functions provided are addition, subtraction, multiplication, division, square root, and percentage. Use the back space on the top right to delete a digit mistakenly entered.

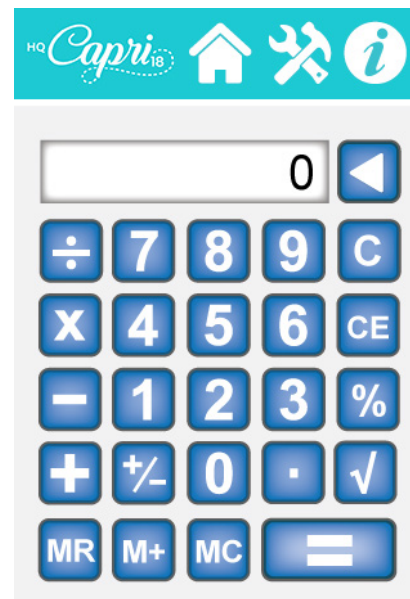

Diagnostics Screen

Six different diagnostics tests can be performed on the machine. These functions test the motor control operation, the foot pedal, and the internal position sensors.

- Motor Sensor Test
- Speed Sensor Test
- Motion Sensor Test (Stitch Regulation)
- Needle Sensor Test
- Tension Calibration
- Foot Pedal Test

Press the **Home** button to return to the Main menu screen or the **Tools** button to return to the Diagnostics screen option.

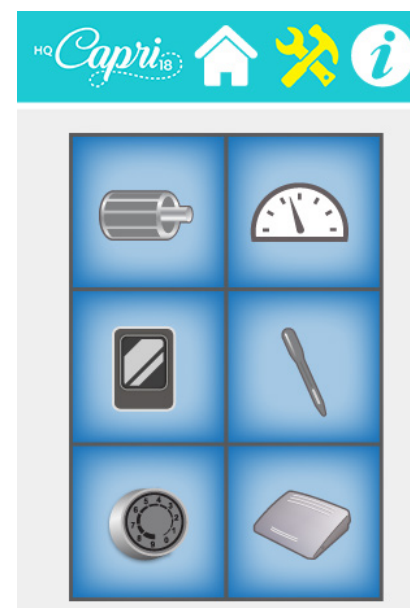

Diagnostics Tests

Motor Sensor Test

The Motor Sensor Test helps you determine if there may be a problem with the HQ Capri motor. Slowly rotating the hand wheel should result in an audible beep. If you get a constant solid beep or no beep at all, this indicates a failed test and the machine should be inspected by a qualified Handi Quilter repair technician.

Press the **HOME** button to return to the Main menu screen or the **Tools** button to return to the Diagnostics menu screen.

Speed Sensor Test

The Speed Sensor test can help determine if there is a problem with the HQ Capri speed sensor. Before performing this test, remove the bobbin case and the top thread. Press the foot pedal so that the machine will begin slowly running. The white box will show a number that should stabilize at 100 if the sensor is functioning properly. Release the foot pedal to stop the machine.

Press the **Home** button to return to the Main menu screen or the **Tools** button to return to the Diagnostics menu screen.

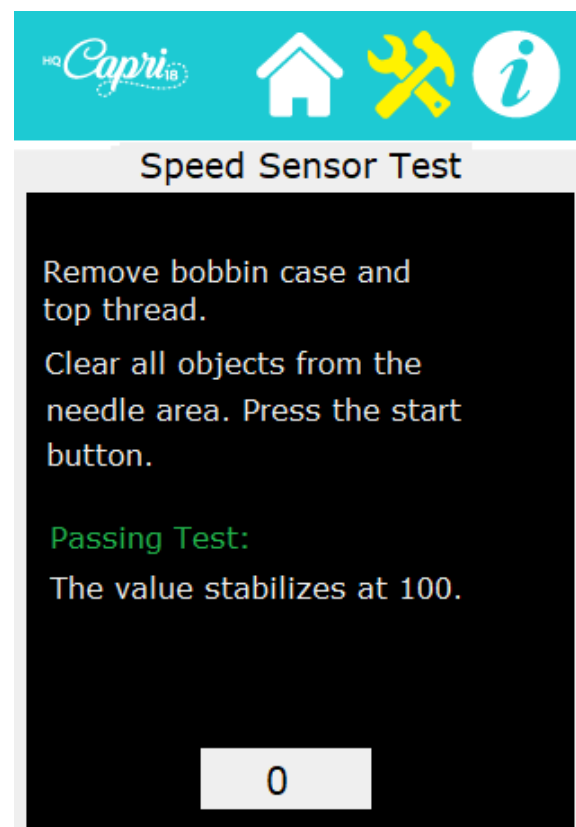
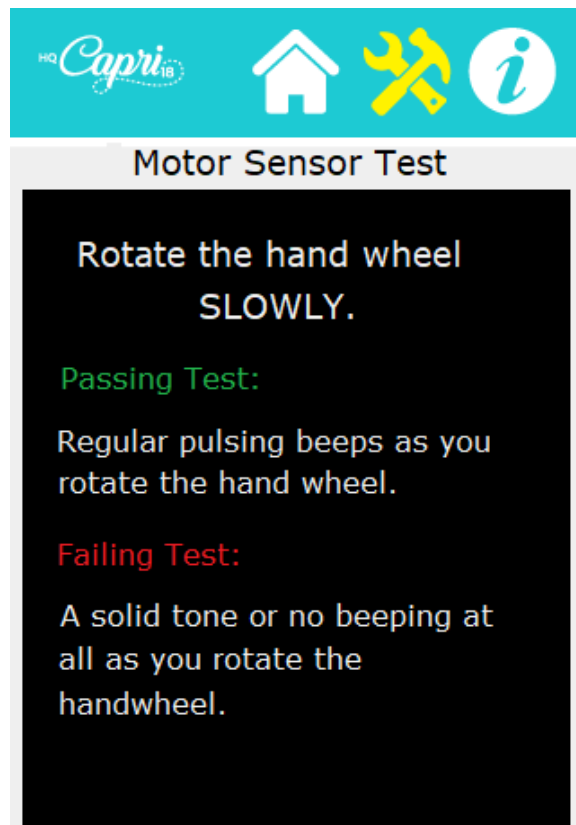

Motion Sensors

This test checks the movement of the fabric across the sensors for the stitch regulation.



Motion Sensors

The machine will beep as fabric is moved across the sensors.
If there is no beep check the cable connection.

The values below will help a technician determine the quality of the sensor data when fabric is on the sensors.

39017 37191

Needle Sensor Test

The Needle Sensor test will indicate whether the needle position sensor is functioning properly. Rotating the hand wheel should result in a beep for a third of a stitch cycle followed by no beep for the other two-thirds.

If you hear a constant beep or no beep at all for a full 360° rotation of the hand wheel, this indicates a failed test and the machine should be inspected by a qualified Handi Quilter repair technician.



Needle Sensor Test

Rotate the hand wheel.

Passing Test:
Solid beep for 1/3 of a stitch cycle, no beep for the rest of the cycle.

Failing test:
No beep or solid beep as you rotate the hand wheel one full rotation.

Tension Calibration

The Tension button on the Diagnostics menu resets the tension device. Only calibrate the tension device under the direction of Handi Quilter technical support.

When calibrating the tension, do the following:

1. Remove the tension knob.
2. Gently press the spring against the tension discs while not compressing the spring.
3. While holding the spring in place, press Reset.
4. When calibration is complete, replace the tension knob.

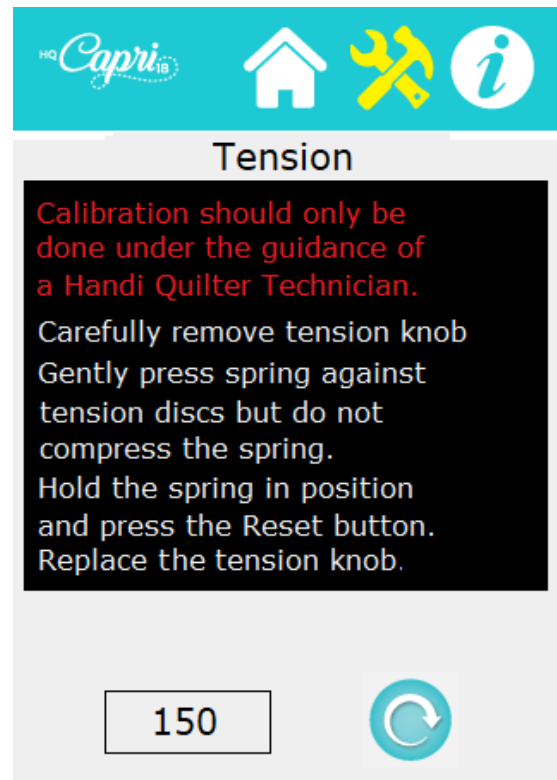

Foot Pedal Test

The Pedal test will help determine if there is a problem with the HQ Capri foot pedal. Slowly depress the foot pedal, a percent of depression will appear in the white box. The foot pedal should be controllable from 0 to 100%. Press the **Home** button to return to the Main menu screen or the **Tools** button to return to the Diagnostics menu screen.

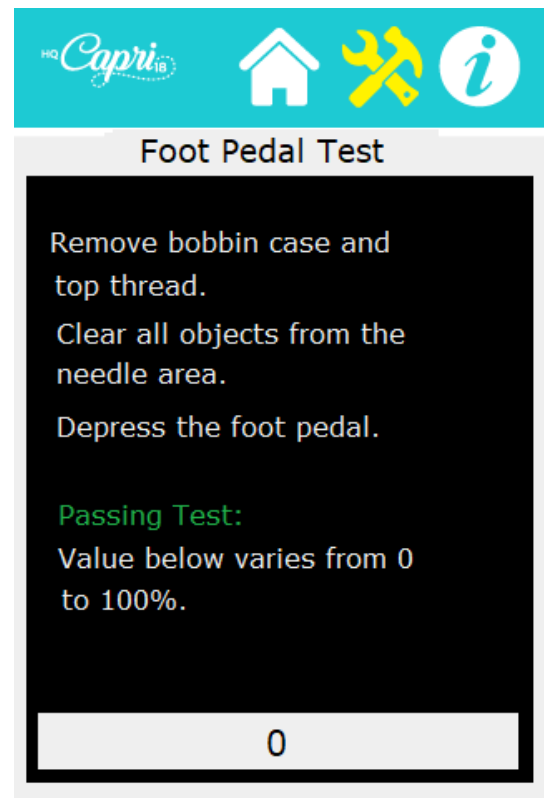

Language

Set Language

1. Touch the Tools icon in the toolbar. The Tools screen appears.
2. Press the flag icon to rotate through the language options: English, French (Français), German (Deutsch), and Spanish (Español).
3. When the flag representing the language you want to use appears, press the **Home** button to return to the Main screen.

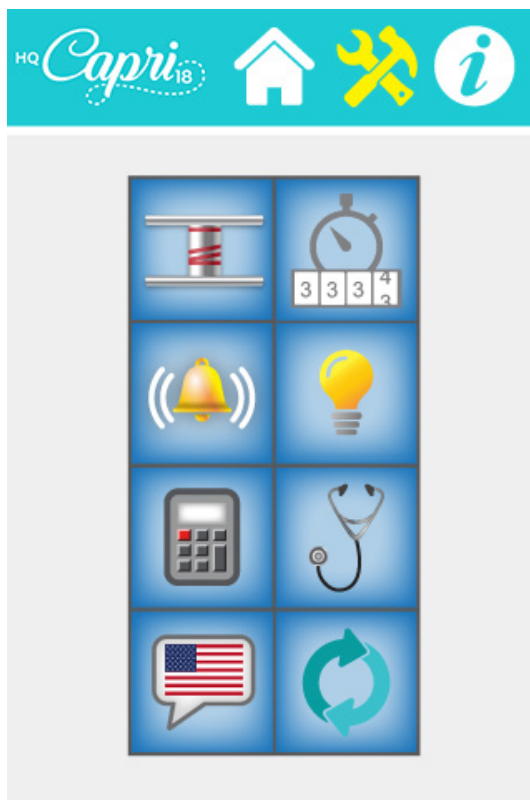

Update

- ➔ **IMPORTANT:** Power down the machine and disconnect the InSight table insert interface from the front bobbin area of the machine, then power on and update the machine and/or the display. Once updated, power down the machine, reconnect the InSight interface and power up again. The InSight communication can disrupt the programming sequence and can corrupt the program file.

1. Place the USB stick into the port on the right side of the display as shown.
2. Wait for the color of the selection buttons to change from gray to blue/green.
3. Select the machine, display, or sensor icon for update as needed.
4. When the display update button is selected the screen will go blank and you will hear three beeps until the update has completed and the screen comes back on.
5. Power down the machine between doing the display and the machine updates.
6. When the machine update button is selected, the display screen stays on and a count down number appears above the machine update button icon. A four tone signal sounds when the update on the machine is done.

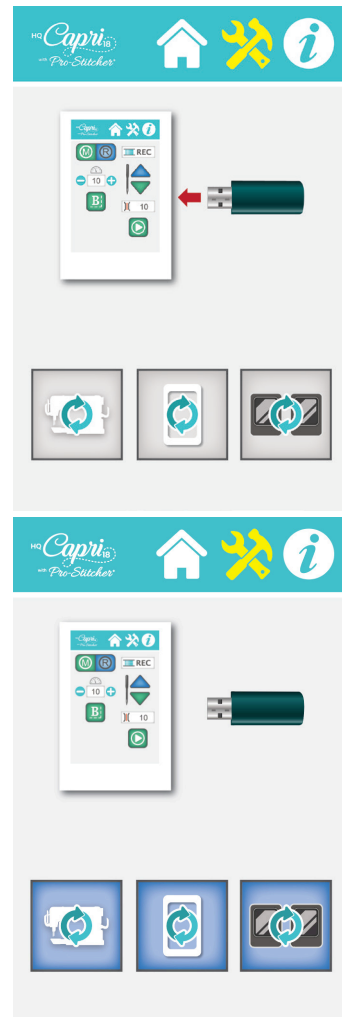

System Information Screen

(A) The Lifetime stitch counter counts the number of stitches the machine has performed. The Lifetime count is the total number of stitches made since the machine was built. The Lifetime counter cannot be reset and should be used as an indicator to determine when general machine maintenance should be performed by an authorized Handi Quilter Retailer.

(B) The foot controller icon in the middle of the screen indicates whether the foot controller is attached. A red "X" will appear if it is not connected properly.

(C) The left and right sensor icons indicate whether the sensors are functioning. A red "X" will appear if sensors are not functioning properly.

(D) Information contained in the white boxes at the bottom of the screen identifies the electronics board revision numbers as well as the firmware revision numbers of the HQ Capri machine the display version, and the sensor version.

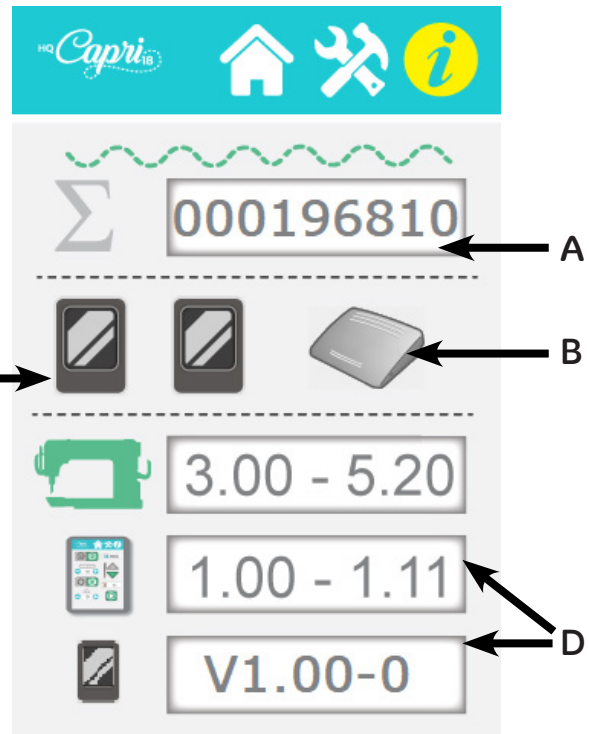

Press the **Home** button to return to the Main menu screen or the **Tools** button to return to the Diagnostics menu screen.

Getting Started Quilting

Thread Requirements

Be sure to choose high quality threads for your valuable heirloom quilts.

Needle Requirements

For general quilting, a size 16/100 needle will accommodate most threads and fabrics. Heavier threads, such as top stitch and some decorative threads, require a larger needle such as 18/110 or 21/125. Heavier fabrics such as denim, canvas, or densely woven fabric may require a larger needle.

To Prepare for Quilting

With any quilting machine, it is important to understand the basics of free motion quilting. The HQ Capri quilting machine does not have feed dogs like domestic machines; therefore, the fabric does not automatically feed under the hopping foot. The operator controls the machine sewing speed with the My Speed setting and the foot pedal, and moves the fabric to get an even, consistent stitch.

In order to become comfortable using the HQ Capri, quilters can begin with a few simple techniques using a sample quilt sandwich (two pieces of fabric with a layer of batting between them). Set the machine at a medium My Speed setting (700 SPI) and begin moving the fabric until you become accustomed to the resistance. By moving the fabric faster, the stitches begin to elongate. The My Speed setting can either be increased or the fabric can be moved slower to get the stitches back to the desired length. By moving the fabric slower, the stitches get shorter and can build up on top of each other, breaking the thread or making it extremely difficult to unpick.

The My Speed setting can be decreased or the foot pedal released slightly, while maintaining a constant motion with the fabric, to bring the stitches back to the desired length.

When quilting, relax your hands and maintain a light touch on the fabric. Gripping the fabric too tightly may cause body tension resulting in poor quilting quality and discomfort.

Different colors of fabric may require different brightness settings for the LED light ring to prevent eye strain.

Troubleshooting

You can correct many problems on your own. If you need additional help, contact your local, authorized Handi Quilter retailer. You can also contact Handi Quilter technical solutions at 1-801-292-7988, 1-877-MY-QUILT (697-8458), or TechCares@HandiQuilter.com.

First check the following:

1. The AC power cord is properly connected and both power switches are turned on.
2. Confirm that all cables are properly seated into their connections.
3. Turn off the machine completely. Wait for at least ten seconds and then turn it back on.

If the above checks did not solve the problem, refer to the information below.

Skipped Stitches	Corrective Measure(s)
The needle is damaged, dull, bent, or installed improperly	<ul style="list-style-type: none"> • Replace the needle often, normally once or twice per day for continuous quilting or at least once per quilt. Use only the recommended needle system. • Always change the needle if the needle has struck any hard object such as a pin, etc. The tip of the needle can become damaged or burred, resulting in fabric damage as well as skipped stitches, thread breakage, or shredding. • Always change the needle if it has been hit, bumped or pulled off center while maneuvering the machine over the quilt. A slightly bent needle can be a major cause of skipped stitches.
Incorrect needle size	<ul style="list-style-type: none"> • Use the proper size needle for the work and thread being used. Some battings and fabrics used in quilting may constrict or impede the thread passing through the front groove of the needle. This diminishes the loop required for stitch formation. Typically, a larger needle will solve the problem. However, using certain smaller sizes of needles and ball pointed needles solve some specific problems. You will need to experiment to determine which works best with your combination of fabric, thread, and batting.
Thread tension too tight	<ul style="list-style-type: none"> • Check bobbin case tension and then check top thread tension. (For more information about adjusting tension, see <i>Bobbin and Bobbin Tension</i> and <i>Easy-Touch Tension™</i> in the <i>Using Your Machine</i> section of this manual.)
Improper threading	<ul style="list-style-type: none"> • Ensure that the machine is threaded correctly.
The needle is not positioned properly	<ul style="list-style-type: none"> • Position the needle properly to the needle bar. Inspect the position of the needle to make sure the needle is at the 6 o'clock position. When you stand directly in front of the needle (facing the bobbin case side of the machine), you will see the entire needle eye directly facing you. This is 6 o'clock position. • Make sure (a) the needle is installed all the way into the needle bar to the needle-stop hole, (b) the long groove in the needle is toward the front (bobbin case side), and (c) the scarf (scooped out part of the back of the needle) is toward the back of the machine. • The needle can sometimes be rotated to 5 o'clock (slightly right) or 7 o'clock (slightly left) to adjust for a more positive thread loop pickup by the hook point.

The Needle Breaks	Corrective Measure(s)
The needle is bent or not installed properly	<ul style="list-style-type: none"> • Replace the needle. Make sure that the needle is pushed into the needle bar clamp until it can go no further. Visually check that it is up to the top of the sight hole above the needle bar clamp screw. If the needle isn't installed properly, it can cause damage in the bobbin area and throat plate.
The needle hits the throat plate	<ul style="list-style-type: none"> • Correctly position the needle, throat plate, or hopping foot. Replace with a new needle.
Stitches are Puckered	Corrective Measure(s)
The tension is not balanced	<ul style="list-style-type: none"> • Balance the tension of the needle thread after ensuring the bobbin tension is adjusted correctly. (For more information about adjusting tension, see <i>Bobbin and Bobbin Tension</i> and <i>Easy-Touch Tension™</i> in the <i>Using Your Machine</i> section of this manual.)
Needle too large for quilting fabric	<ul style="list-style-type: none"> • Replace the needle with a size better suited for the fabric.
Poor Stitch Quality	Corrective Measure(s)
The tension is not balanced	<ul style="list-style-type: none"> • Balance the tension of the needle thread after ensuring the bobbin tension is adjusted correctly. (For more information about adjusting tension, see <i>Bobbin and Bobbin Tension</i> and <i>Easy-Touch Tension™</i> in the <i>Using Your Machine</i> section of this manual.)
Bobbin case is damaged, corroded, dirty, etc.	<ul style="list-style-type: none"> • Since thread slides over the surface of the bobbin case at a high speed, make sure the case is free of any lint or foreign matter that could impede thread passage through the machine.
Moving the quilt too fast for needle speed selected (Manual mode)	<ul style="list-style-type: none"> • Synchronize quilt movement and needle speed to get your desired stitch length. Elongated stitches are an indication of moving the quilt too fast for the current speed.
Tension is Poor	Corrective Measure(s)
Lint caught under the tension spring in the bobbin	<ul style="list-style-type: none"> • If using short-staple threads, inexpensive threads, industrial threads, or coated threads, lint and other material will build up under the tension spring and begin to lift the spring, reducing the spring's ability to compress against the thread. Insert a pin or the corner of a business card under the spring and clear out the lint. The bobbin tension will return fairly close to its preset tension. Test the tension before quilting.

Hand Wheel Won't Rotate	Corrective Measure(s)
Thread is entangled and caught in the hook, creating a thread lock	<ul style="list-style-type: none"> Carefully rock or turn the hand wheel in direction of motion and then the other direction until the thread lock breaks free. Once the hand wheel can be turned freely, remove the thread from the hook and basket. Now re-oil the hook and make sure the hand wheel turns freely without the hook hitting the needle. It is possible for a thread lock to cause a timing problem.
Thread Nests Under Quilt	Corrective Measure(s)
Not enough tension on top thread	<ul style="list-style-type: none"> Check that the machine is threaded correctly. Make certain that the thread is flossed snugly in place between the two tension discs. If the machine is threaded correctly, tighten top tension by rotating the tension knob clockwise. (For more information about adjusting tension, see <i>Bobbin and Bobbin Tension</i> and <i>Easy-Touch Tension™</i> in the <i>Using Your Machine</i> section of this manual.)
Improper threading	<ul style="list-style-type: none"> Refer to threading diagram and threading instructions.
Thread Backlash	Corrective Measure(s)
Bobbin thread tangles within the bobbin case, tangles and winds onto the hook spindle, or occasionally forms loops on the bottom of the quilt	<ul style="list-style-type: none"> Make sure the bobbin is in the bobbin case correctly and the thread is coming out from under the tension spring. The bobbin should rotate clockwise when the thread is pulled.
Motor Fails to Run	Corrective Measure(s)
On/Off switch turned off	<ul style="list-style-type: none"> Make sure the power switch is turned on.
Machine not receiving power	<ul style="list-style-type: none"> Check that the power connector is securely plugged into the back of the machine and the three-prong end is plugged into the power source.
Thread Breaks	Corrective Measure(s)
Thread is poor quality or may have severe twisting or thread rot	<ul style="list-style-type: none"> Look for severe twisting of threads when approximately 12 to 15 inches has been pulled off, with the ends pinched together. Cotton threads are particularly susceptible to dry rot or wet rot which makes thread brittle. Do not use poor quality thread, or thread that is rotted or brittle.
Top and bobbin tensions not balanced	<ul style="list-style-type: none"> Balance the tension of the needle thread after ensuring the bobbin tension is adjusted correctly. (For more information about adjusting tension, see <i>Bobbin and Bobbin Tension</i> and <i>Easy-Touch Tension™</i> in the <i>Using Your Machine</i> section of this manual.)

The machine head has been threaded incorrectly or thread spools are not positioned correctly	<ul style="list-style-type: none"> • Check that the machine is threaded correctly. • Inspect for accidental double wrapping of thread on thread guides. • Inspect the thread mast, making sure the eyelets of the mast are directly over the spools. • Inspect the vertical positioning of the thread cones. Tipped cones can dramatically affect thread tension and can cause breakage.
Debris in tension discs	<ul style="list-style-type: none"> • Inspect for particles and remove any fuzz or debris.
Bobbin rotation is not smooth	<ul style="list-style-type: none"> • Change the bobbin. The slightest hesitation of the bobbin rotation can be the cause of dramatic tension change and thread breakage.
Needle is burred, bent or dull, or installed incorrectly	<ul style="list-style-type: none"> • Change the needle at least once per quilt. Make sure the needle is installed to the top of the stop hole in the needle bar.
Needle not suitable for thread	<ul style="list-style-type: none"> • Replace the needle to one better suited for the thread. Use the proper size needle. Refer to on chart on page 16.
Hesitating too long at one point in quilting motif	<ul style="list-style-type: none"> • Move more quickly so stitches don't overlap or build up. When starting the machine, begin moving fabric immediately. Sewing in one place too long will cause the thread to break.
Improper needle/hook relationship	<ul style="list-style-type: none"> • Machine timing needs to be checked. Consult an authorized Handi Quilter technician.
Damage or burr at needle hole of throat plate or other thread handling part	<ul style="list-style-type: none"> • If thread is shredding at the throat plate, check for burrs or jagged edges. Gently rub with emery cloth to remove the sharp edge. Consult a repair technician to polish any hard-to-reach or delicate areas, or if the burr is inside the throat.
Wrong type of needle	<ul style="list-style-type: none"> • Use only the needles recommended by Handi Quilter (134, sizes 12 through 21).
Other possible problems	<ul style="list-style-type: none"> • Needle too close to hook, causing friction and possible collision of hook point and needle (causing broken thread). • Needle plate damage • Hook damage • Broken needles or damaged needle bar clamp
Nothing visible on the display	Corrective Measure(s)
Display cables unplugged	<ul style="list-style-type: none"> • Locate the black cable that plugs into the touch-screen display. Turn off machine. Connect the cable to the side of the machine and to the display. Make sure both ends are plugged in securely.

Accessories

(Available from your local HQ Retailer or at www.HandiQuilter.com)

Horizontal Spool Pin



An optional horizontal spool pin is available for use with delicate threads such as metallics or holographic threads or for specialty threads that are wound on a spool (not a cone). Some threads twist and break if fed from a vertical spool in vertical position.

HQ Capri 18" Table Extension



Expand your original HQ Capri table with HQ Capri Table Extensions. Each extension measures 18" x 30". Purchase one or two to provide extra support for large projects.

Adding two extensions will expand the original table to a full six feet in width (one extension shown above).

Large Foot Pedal

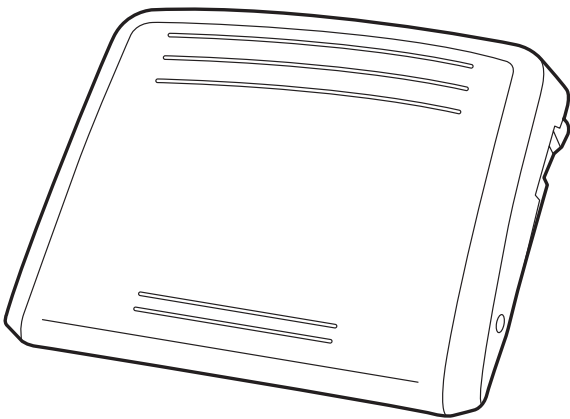

The optional large foot pedal provides an upgraded user experience.

Handi Feet



Couching Feet



Micro Foot



Glide Foot 2



Sure Foot



Echo Feet 2



Square feet

Appendix 1

Federal Communications Commissions (FCC) Declaration of Conformity (For USA Only)

Responsible Party: Handi Quilter, Inc.
501 North 400 West
North Salt Lake, UT 84054

declares that the product

Product Name: HQ Capri

complies with Part 15 of the FCC Rules. Operation is subject to the following two conditions: (1) this device may not cause harmful interference, and (2) this device must accept any interference received, including interference that may cause undesired operation.

This equipment has been tested and found to comply with the limits for Class B digital device, pursuant to Part 15 of the FCC Rules. These limits are designed to provide reasonable protection against harmful interference in a residential installation. This equipment generates, uses, and can radiate radio frequency energy and, if not installed and used in accordance with the instructions, may cause harmful interference to radio communications. However, there is no guarantee that interference will not occur in a particular installation.

If this equipment does cause harmful interference to radio or television reception, which can be determined by turning the equipment off and on, the user is encouraged to try to correct the interference by one or more of the following measures:

- Reorient or relocate the receiving antenna.
- Increase the separation between the equipment and receiver.
- Consult the dealer or an experienced radio/TV technician for help.

Changes or modifications not expressly approved by the manufacturer or local sales distributor could void the user's authority to operate the equipment.

Canadian Department of Communications Compliance Statement (For Canada Only)

This digital apparatus does not exceed the Class B limits for radio noise emission from digital apparatus as set out in the interference-causing equipment standard entitled "Digital Apparatus", ICES-003 of the Department of Communications.

Radio Interference (Other than USA and Canada)

This machine complies with EN55022 (CISPR Publication 22) /Class B and AUS/NZ 55022/Class B.



Designed by a Quilter, for Quilters.®

501 North 400 West
North Salt Lake, UT 84054
801-292-7988 • 877-697-8458
Email: sales@handiquilter.com
www.HandiQuilter.com

Warranty issues should, whenever possible, first be submitted to the Authorized Retailer who completed your service and training. These Retailers have been selected for their dedication to customer satisfaction and have been trained in technical service. They also may provide follow-up advice, training, service, accessories, and other services.

HQ Authorized Retailers may offer their own warranties in addition to those offered by the manufacturer, but do not obligate the manufacturer.

HQ Quilting Machine Limited Warranty

Handi Quilter, Inc. (*hereinafter HQ*) offers a limited warranty on the HQ Quilting Machine (*hereinafter "Machine"*) to be free of defects in workmanship and materials under normal use upon the terms and conditions hereinafter set forth:

- (a) **90 day Limited Warranty:** During the first 90 days from date of purchase, HQ will repair any manufacturing defect without charge for parts or labor. All subsequent warranties include parts costs only.
- (b) **5-year Mechanical Warranty:** For any mechanical failure within this period. Manufacturer will provide free replacement parts, customer pays for labor and shipping.
- (c) **5-year Electronic/Electrical Warranty:** The electric/electronic components are warranted to be free from manufacturing defects for five years from the date of purchase. If any defect is reported within this period, manufacturer will provide free replacement parts, customer pays for labor and shipping. The 5-year electronic/electrical warranty will be invalid if the machine is left plugged into a power source when not in use.
- (d) **10-year Limited Manufacturer's Warranty:** HQ warrants the sewing head is free of casting or machining imperfections causing product failure. This warranty does not extend to mechanical or electronic/electrical parts, which are covered under a separate warranty, or consequential damage to the head caused by mechanical or electronic/electrical part failures beyond their warranty period.

The limited warranty stated in sections (b), (c) and (d) above shall be limited solely to the replacement of parts which, in the opinion of HQ, are defective in workmanship or material and are returned to HQ, or an authorized repair facility, or such other point or place that may be designated by HQ. All other costs, including cost of freight and shipment for repair under this warranty, shall be the customer's costs.

The machine registration card must be completed and received by HQ before warranty is valid.

Warranty Exclusions: HQ shall have no obligation for any claim under this warranty if the machine has been misused, abused, neglected, damaged in transit or has been altered from the standard specifications established by HQ, or if proper maintenance and lubrication have not been timely performed.

No warranties extend beyond the express warranty offered. HQ disclaims all other warranties, express or implied, regarding the Products, including any implied warranties of merchantability or fitness for a particular purpose. In the United States, some laws do not allow the exclusion of the implied warranties.

Specific exclusions of warranty limitations include, but are not limited to, the following:

- General, consequential, incidental or special damages including damage to fabric or material, the cost of rework or lost profits, the cost of installation or removal of any Products, and any inspection, testing, or redesign caused by any defect or by the repair or replacement of Products arising from a defect in any Product.
- Products which are received by HQ improperly packaged, altered, or physically damaged.
- Counterfeit or altered label(s) or stickers.
- Broken pins on connectors.
- Stripped screws or nuts.
- Connector(s) damaged, cracked, missing or broken.

- Missing, torn or punctured seal(s).
- Any use besides machine quilting applications using customary fabrics, threads and accessories.
- Operator error in the customary use of the Product.
- Internal adjustments, tampering or parts replacement done by anyone except authorized Retailers or customers specifically authorized by Handi Quilter Customer Support or warranty repair personnel on a case by case basis.

The warranty does not cover and the user assumes the risk of and there is hereby excluded any liability to HQ for failure, defects, loss, deterioration, personal injury or damage which are due to: (1) ordinary wear and tear or exposure, (2) abuse, misuse, negligence, or (3) use of parts not authorized by HQ.

In no event shall HQ be liable to the purchaser of the Machine or to third parties for special or consequential damages, including, but not limited to, death or personal injuries.

HQ does not assume, or authorize any person to assume on its behalf, any other obligation of liability other than that set forth herein.

Some states do not allow exclusion of limitation of incidental or consequential damages, so above limitation or exclusion may not apply. This warranty gives the purchaser specific legal rights and the purchaser may also have other rights, which may vary for State to State.

Exclusive Remedy: Remedy is limited to the repair or replacement of the defective Product. HQ may elect which remedy or combination of remedies to provide at its sole discretion and shall have a reasonable time, after determining that a defective Product exists, to repair or replace the defective product. Replacement Product may be from new or serviceable used parts. HQ's warranty applies to repaired or replaced Products for the balance of the applicable period of the original warranty or ninety days from the date of shipment of a repaired or replaced Product, whichever is longer.

HQ's entire liability for any defective Product shall in no event exceed the purchase price for the defective Product. This limitation applies even if Handi Quilter cannot or does not repair or replace any defective Product.

Service under the above warranties may be obtained by returning the quilting machine, with proof of purchase, to the authorized Retailer from whom the machine was purchased, a local Retailer, or to Handi Quilter Customer Support.

Any product to be returned to the factory, either by customers or Retailers, must be accompanied by a Return Material Authorization Number (RMA). RMAs may be obtained by email (sales@handiquilter.com) or by calling customer support toll free at 1-877-697-8458. If it is determined that the Product may be defective, an RMA number will be issued with instructions for Product return. An unauthorized return (a return without an RMA number) will be shipped back to customer at customer's expense. Authorized returns are to be shipped prepaid and insured in an approved shipping container. The original box and packaging materials should be kept for storing or shipping.

Shipping Costs: Shipping is the responsibility of the customer.

Product Service and Maintenance: Replace needles every 2 to 4 hours (1 to 2 per large quilt) and lubricate bobbin hook every 3 to 4 hours of use. Periodically check the thread tensioner. Use canned air to clean out all lint, loose thread, or obstructions from the bobbin hook.

Servicing is recommended annually from a qualified HQ Retailer. Servicing will cover belt tensioning, encoder positioning, bearing retainers, hook axial play and timing, presser and needle-bar adjustment and internal lubrication to take-up lever, hopping foot levers, bushings/bearings.

**Handi Quilter, Inc.
Customer Relations
501 North 400 West
North Salt Lake, Utah 84054**

Handi Quilter Machine Warranty

Mail or Fax completed Warranty Registration Card **within 30 days of purchase**. If you have questions, email HQcares@HandiQuilter.com or call Customer Relations at 1-877-697-8458. Online warranty registration is also available at HandiQuilter.com.

MAIL TO: Handi Quilter, Inc.
Warranty Registration Dept.
501 N 400 W
North Salt Lake, Utah 84054

FAX TO: 801-294-3011

The HQ Quilting Machine warranty is 10 years manufacturer's warranty on casting and machining of the case, 5 years electronic/electrical, and 5 years mechanical. Check with your local HQ Retailer for details on service or making warranty claims.

HQ Quilting Machine Model (check one): HQ Sweet Sixteen® HQ Simply Sixteen® HQ Capri®
 HQ Avanté® HQ Amara® HQ Fusion® HQ Forte® HQ Infinity®

Customer Name: _____

Company/Business Name (if applicable): _____

Address: _____

City, State, Zip: _____

Daytime Phone: _____ Evening Phone: _____

Fax: _____ Email: _____

HQ Serial Number: _____ Order Number (5 digits): _____

Purchase Date: _____ Date Machine Received: _____

Location of Purchase (Shop or Show name, City & State): _____

Type of use intended: Home/Personal Some commercial Share w/Friends Mostly commercial
 Other _____

Type of machine-quilting skills: Novice Intermediate Experienced

Skill adjusting sewing machines: Novice Intermediate Experienced

Signature: _____ Date: _____

Cut along dotted line and mail or fax this registration information within 30 days of purchase.

This page was intentionally left blank.

Cut along dotted line and mail or fax this registration information within 30 days of purchase.

HQ Capri™ with HQ InSight™ Table Training Checklist and Certificate



Designed by a Quilter, for Quilters.®

You are entitled to a one-time free introductory training class on the use of your HQ Capri as well as free adjustments for 60 days and any repairs covered by the warranty. Present this checklist to your authorized HQ Retailer to receive these free services.

Table

- How to install table insert
- How to adjust height

Machine Setup

- Identify the main parts of the machine and where they are located
- Ensure machine is properly installed into table
- Check all cable connections
- Ensure power outlet is available and does not cause a trip hazard
- Recommend and explain the importance of a power strip with surge protection
- Ensure the table is level and height adjusted
- Show how to wind a bobbin (including how to adjust the tensioner and the capacity lever)

Machine Operation

- How to turn the machine on and off
- How to change the needle
- How to change the Handi Feet
- How to properly thread the machine
- How to set the bobbin tension; teach the drop test
- How to set the upper tension
- How to bring up the bobbin thread
- How to use the menus: explain each menu
- How to adjust light settings
- How to switch between stitch regulation and manual mode
- How to set the speed in manual mode; how to set the presets
- How to set the stitches-per-inch in stitch regulation
- How to use Cruise stitch regulation
- How to use Precision stitch regulation
- How to use the foot control
- How to use HQ InSight sensors
- How to use the color touch-screen
- How to use the functions of the touch-screen
- How to set the presets and My Speed
- How to use needle up/down and tie-off buttons
- How to tie off

Machine Maintenance

- How to oil the bobbin hook: where, how, and when
- How to clean the bobbin hook area (canned air permissible; GENTLY brush (avoiding wires))

IMPORTANT: Read before signing

By signing this training checklist you are acknowledging you have been personally instructed in the operation of the Handi Quilter machine you purchased. Additional training by this HQ Retailer or any other HQ Retailer may result in being charged for additional instruction.

Customer Name _____

Customer Signature _____

Training Date _____

Trainer Name _____

Retailer Signature _____

HQ Retailer Business Name _____

Business City and State/Province _____

Machine Serial Number _____

HQ Retailer: To register training services provided, return completed and signed certificate by FAX (1-801-294-3011) or MAIL:

**Handi Quilter
Training Checklist
501 North 400 West
North Salt Lake, UT 84054**

Retain a copy for your records.

This page was intentionally left blank.



Handi Quilter, Inc.
501 N 400 W
North Salt Lake, UT 84054

1-877-MY-QUILT (697-8458) • www.HandiQuilter.com

HQ Capri™ is part of the family of innovative quilting products from Handi Quilter®



PRINTED 06/2020

© 2019 Handi Quilter, Inc. All rights reserved. Printed in the U.S.A.